

Training Course

Measuring Technology and Troubleshooting for Watches



Document Nr. 71.1010D35e
Rel. 1.1 / October 2010

© 2002-2011 Witschi Electronic Ltd, CH-3294 Büren a.A., Switzerland

All rights reserved. The use of the texts and pictures, is copyright adverse and punishable also only in part without written permission of the company Witschi Electronic Ltd. This applies in particular to the duplication, translation or the use in course documents or electronic systems.

Witschi Electronic Ltd

Bahnhofstrasse 26 – CH-3294 Büren a.A. – Tel. +41 (0)32 352 05 00
Fax +41 (0)32 351 32 92 – welcome@witschi.com – www.witschi.com



About us

Witschi Electronic Ltd develops, manufactures and sells

Innovative Test- and Measurement Technology for:

- Watch production
- Watch service
- Testing devices for the automotive industry, medical industry and instrument manufacturing

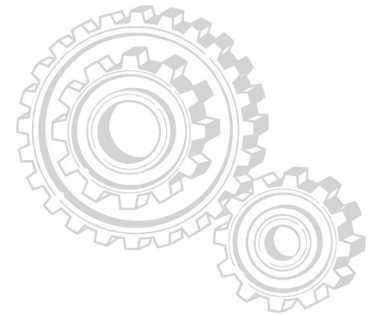

Our quality claim

As a world leading company in matters of test and measurement technology for watches and other micro technical products we rely on the highest quality, future-orientated development work and reliable service performances. In order to meet the demands of the market the company has been built up on the strength of highly qualified and competent employees. The ISO 9001:2000 certification too, is a guarantee for the continuation of the quality achieved. Our customers can hence be assured that they will find an optimal partner in the Witschi Company and the best possible cost/performance ratio in the products received. This is what the name Witschi and the Company's 70 employees stand surety for.

Our know-how

For more than 60 years the Witschi Company has developed, manufactured and sold high quality instrumentation for the field of test and measurement technology. Right from the founding of the Company the declared aim was to provide the watch making industry with the best possible measurement and test equipment. This ambitious target has been consistently achieved. Now all famous enterprises are relying on our products.

During the course of time it has been possible for us to develop ever better products which constantly meet the challenge of the highest demands imposed and represent the yardstick for instrumentation to cope with current market and customer needs. Thousands of satisfied customers throughout the world give proof of that fact.

The potential of our highly qualified engineers and specialists is also a guarantee of trailblazing innovation from the Witschi factory well into the future.

Aim of this Course

The current clock and watch technology demands of us, as a leading manufacturer of measuring instruments, to deal very exactly and reliably with the greatest variety of measuring technology for all possible kinds of watches. This, however, also implies that the users of such instruments need to master a basic know-how about their operation and about the technical functioning principle of watches.

Witschi Electronic has always put customer satisfaction at the top of its business priorities. This basic course is intended to optimize our customers' and the users' knowledge of the Witschi devices and their operating skills in this field.



Mechanical Watches	4
Basic Know-How	5
Main Components	10
Measuring Signals	11
Chronoscope S1	12
Operating Elements and Display	12
Parameter Setting	13
Analysis	14
Error detection with graphical charts	14
Error detection with the Scope function	16
Quartz Watches	20
Basic Know-How	21
Main Components	28
Measuring Signals	29
Analyzer Q1/Twin	30
Operating Elements and Display Panel	30
Watch tests with built in battery	33
Watch tests with external power supply	34
Test of Battery and Components	35
Step Motor Test with Pulse Generator	36
Buzzer Test	36
Graph of the Motor Pulse	37
The Watch stops running - Troubleshooting	38
Tightness Test	39
Standards	40
Precaution in use	41
Test Methods	42
Proofmaster S	45
Operating Elements and Display	46
Operating Proofmaster S	47
Leak Finder	48
Preset Programs	49
Customer-Specific Programs	50
Table - Forces on Watches' Glass and Bottom	51
Witschi's Measuring Tips	52
Mechanical Watches	53
Quartz Watches	54
Tightness Test.....	55

Mechanical Watches Testing Methods Operating the Chronoscope S1



The beat noise of the Swiss lever escapement

Normally, the beat noise of the Swiss lever escapement consists from three different pulses.

The **first** noise occurs when the impulse-pin of the roll strikes the fork of the pallets. This noise is temporally very precise and is therefore used for the graph recording and for calculation of the rate deviation and the beat error (repère).

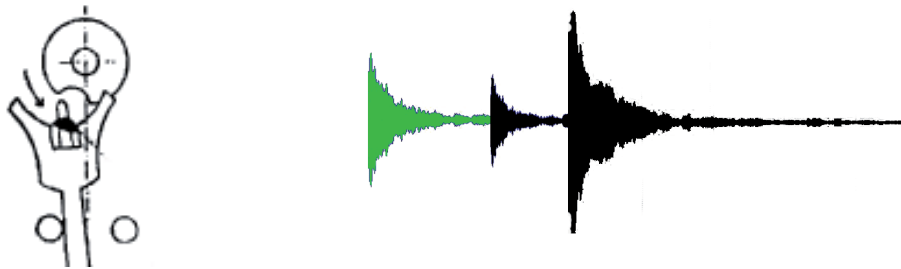

A **second** noise is created when a tooth of the escape-wheel meets the pulse area of a pallet stone and the pallet fork touches the impulse-pin. This very irregular noise can not be used for an evaluation.

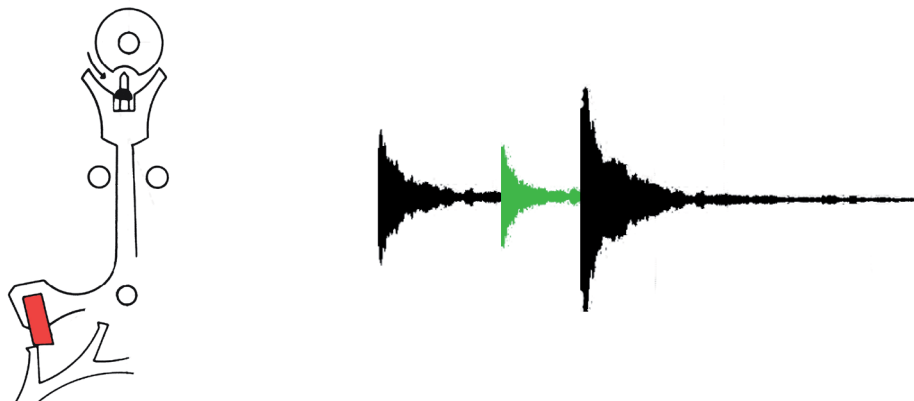

The **third** and most powerful noise is created when a tooth of the escape-wheel meets the locking-plane of the pallet-stone and the lever hits the banking-pin. This noise is evaluated for the calculation of the amplitude.

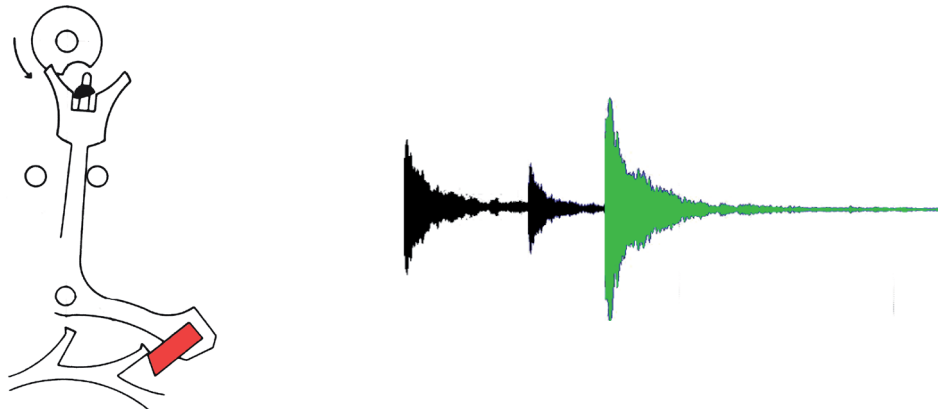

Evaluation of the beat noise

For the evaluation of the beat noise a measuring instrument with a very accurate time base is needed. It is also important that the beginning of the first sound package is reliably detected. If there is a very weak in this first noise of a watch, or if the watch generates strong background noises, the gain must be adjusted accordingly.

For the chart recording the time between two successive watch beats (period) is measured and compared with the nominal value for an accurate rate. If the measured time corresponds precisely to the nominal value, the new dot on the chart is set right by the previous. If the new beat is a bit too early or too late, the new dot, according to the time difference to the nominal value, is shifted up or down compared to the last dot. Therefore the row of dots on the display is according to the rate deviation from straight or angled up or down line.

Example 1: Regular graph

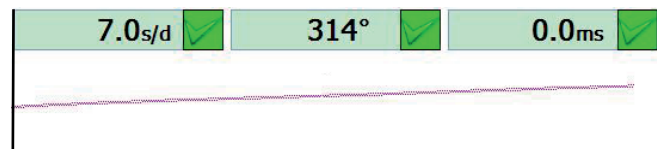

The chart shows not only the rate deviation, but also other temporal irregularities in the beats, such as beat error (repère), defective teeth of the escape-wheel etc.

Example 2: Irregular graph

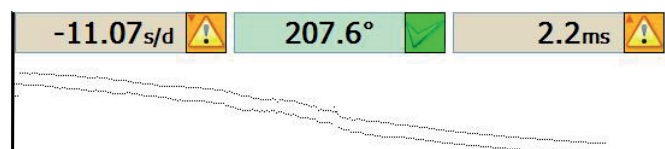

Rate Deviation

To calculate the rate deviation the differences between the measured period and the nominal value are each averaged over the set measuring time, converted in s/24h and displayed on the screen.

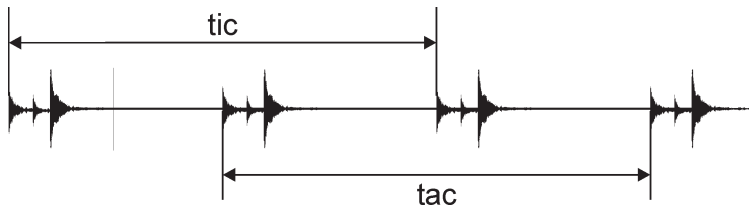

$$\text{Rate} = \frac{\text{rate tic} + \text{rate tac}}{2}$$

Beat Error (Repère)

Asymmetrical oscillation of the balance wheel. The vibration of a balance wheel can be described by the rotating angle. If the watch has stopped, the zero position is defined by the position of the balance wheel. Under a (still existing) "beat error" refers to the fact, that the vibration is not running in all test positions quite symmetrical around the zero position, i.e. the balance wheel is swinging in a direction further than the opposite. This asymmetry may be visible on a test device. The beat error is measured in milliseconds (ms). High quality watches have a special device for setting the beat symmetry.

The graphic below shows a typical beat error. For a nonexistent beat error, t1 and t2 must have identical values.

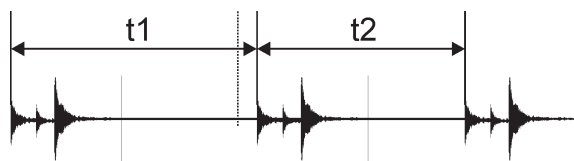

$$\text{Beat error} = \frac{t1 - t2}{2}$$

Functional principle Amplitude-Lift Angle

The angular velocity of the oscillating system (balance wheel with hair spring) passes through the zero point is dependent on its amplitude. The speed is determined by the elapsed time between the trigger signal and the event of the escapement. This period is called lift time of the balance wheel and the means of the balance wheel during this period traversed angle, **Lift Angle**.

While passing through this angle, the impulse-pin (ellipse) remains in contact with the pallet fork. For the most of the standard watch movements the lift angle is about 51°.

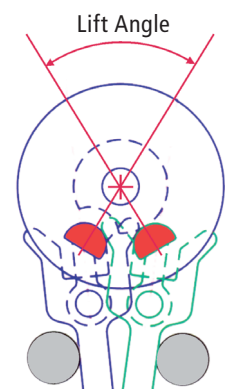

Amplitude

The amplitude is the angle from the equilibrium (idle position of the balance wheel) up to the maximum distance (turning point). The amplitude values of today's popular wristwatches are located at about 260° - 310°. With increasing aging of the oils, this value decreases gradually.

To calculate the amplitude, the time between the first pulse and the third pulse of the beat noise is measured.

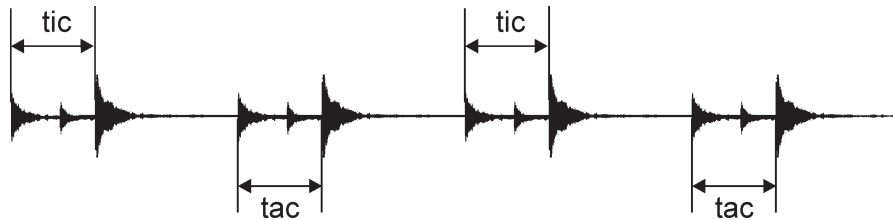

Between these two pulses, the balance wheel rotates a certain angle. This so-called lift angle is determined by the construction of the movement and is entered as a parameter. The larger the amplitude of the balance wheel, the greater is the speed with which it goes through these lift angle and the shorter is the time it needs to traverse this angle.

The amplitude can therefore be calculated from the time between the first and the third pulses in the beat noise, taking into account the beat number and the lift angle.

The distance travelled during a period range of the oscillating balance wheel is a sine function. The full line corresponds to weak amplitude and the dotted line to large amplitude. The horizontal lines of the constant lift angle cut the two sine waves at various points. This results in weak amplitude for a long lift (t2) and large amplitude for a short lift (t1).

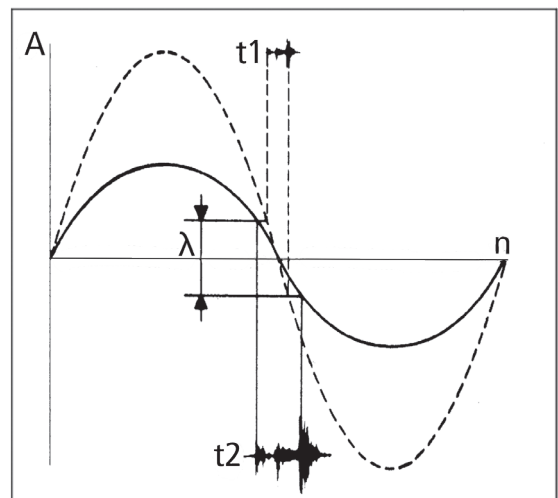

Remark

All Witschi testing devices are equipped with special, selectable test modes. These allow an accurate amplitude measurement of watches with special escapements such as coaxial, AP etc.

Oscillation

The oscillation of the balance wheel is the way from a turning point to another, and back (**A - B - C**).

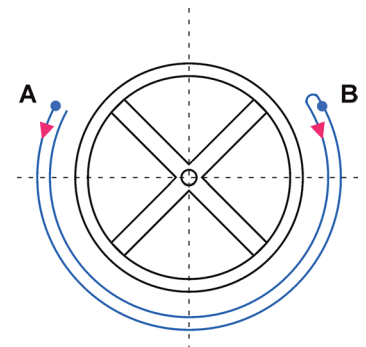

Vibration

Half an oscillation of the balance wheel is called the vibration (**A - B**).

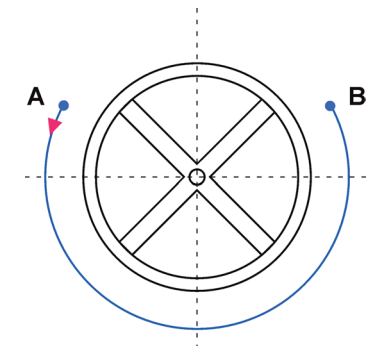

Frequency of the balance wheel

The frequency of the balance wheel (number of oscillations per second) is calculated by the formula:

$$F = \frac{A/h}{2 * 3600}$$

F Frequency (Hz)

A/h Number of vibrations per hour

Some examples:

18'000 A/h \longleftrightarrow 2.5 Hz

21'600 A/h \longleftrightarrow 3 Hz

28'800 A/h \longleftrightarrow 4 Hz

36'000 A/h \longleftrightarrow 5 Hz

View

Part

Characteristics

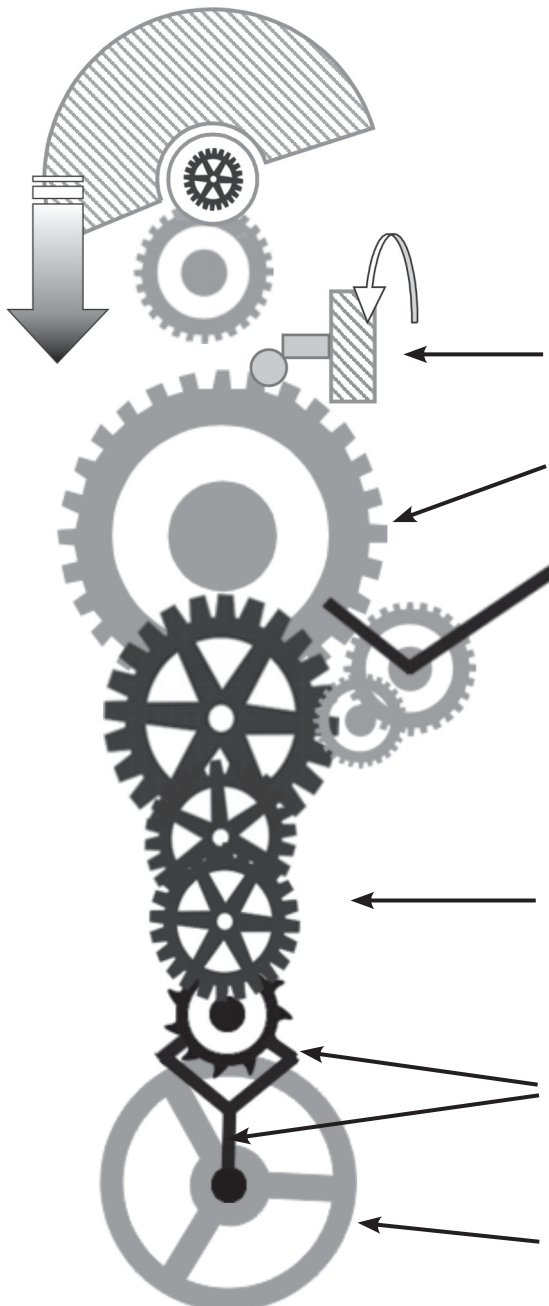

Automatic winding mechanism (only with automatic watches).

Automatic winding with oscillating weight and reduction gear. Winds up automatically the mainspring through natural **arm motion**.

Manual winding of the mainspring with the crown (also possible with automatic watches).

Furnishes the mechanical **driving energy** needed for the watch's function. Power reserve: approximately 48hours. Special watches up to 8 days.

Winding shaft/
crown

Main spring/barrel

Gear train / hand train

Escapement (escape-wheel, pallet fork and ellipse).

Regulating system

Transfers the elasticity to the gear train and the motion to the hands (transmission).

Stops the force transmitted by the train **and transfers** the pulses to the balance wheel, which then starts to oscillate.

Regulates as oscillating system or as a "clock generator" of the watch. Frequency:
2.5 - 5 Hz =
18000 - 36000 beats/hour.

All rate measurements and analysis of mechanical watches are based on the **acoustical signal generated by the escapement (beat noises)**

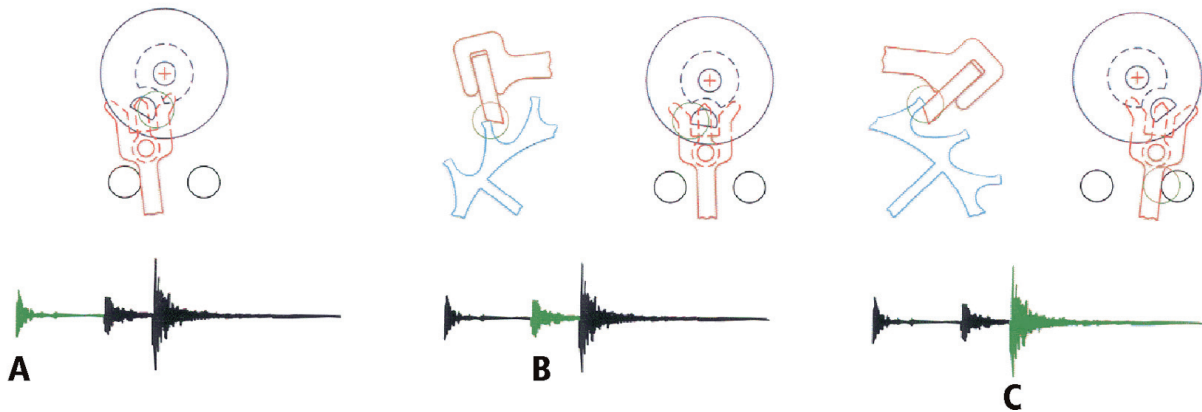

The beat noises, computed by the **Chronoscope S1**, supplies following results and diagrams:

Rate measurement

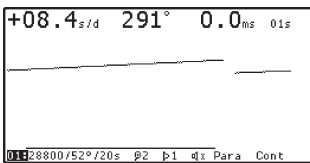

To calculate the rate deviation the differences between the measured period and the nominal value are each averaged over the set measuring time, converted in s/24h and displayed on the screen. The traced diagram indicates the technical state of the watch and its fault, if any.

Amplitude measurement

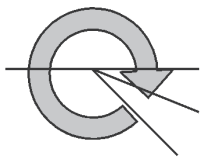

The amplitude is the angle from the equilibrium (rest of the balance wheel) up to the maximum distance (turning point). The amplitude values of today's popular wristwatch are about 260° - 310°.

Beat error (repère)

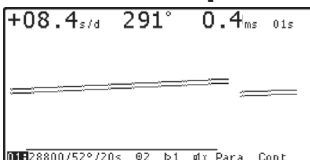

In case of a watch beat error (repère), the period between a tick and a tack is not equal to the period between a tack and a tick. The time difference is averaged over the set measuring time and displayed in ms.

Beat noise

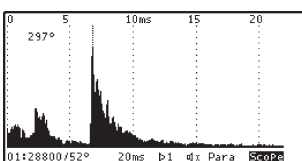

The escapement noise gives informations about miscellaneous fault sources in the regulating parts (balance wheel/balance spring) etc.

Operating Elements and Display

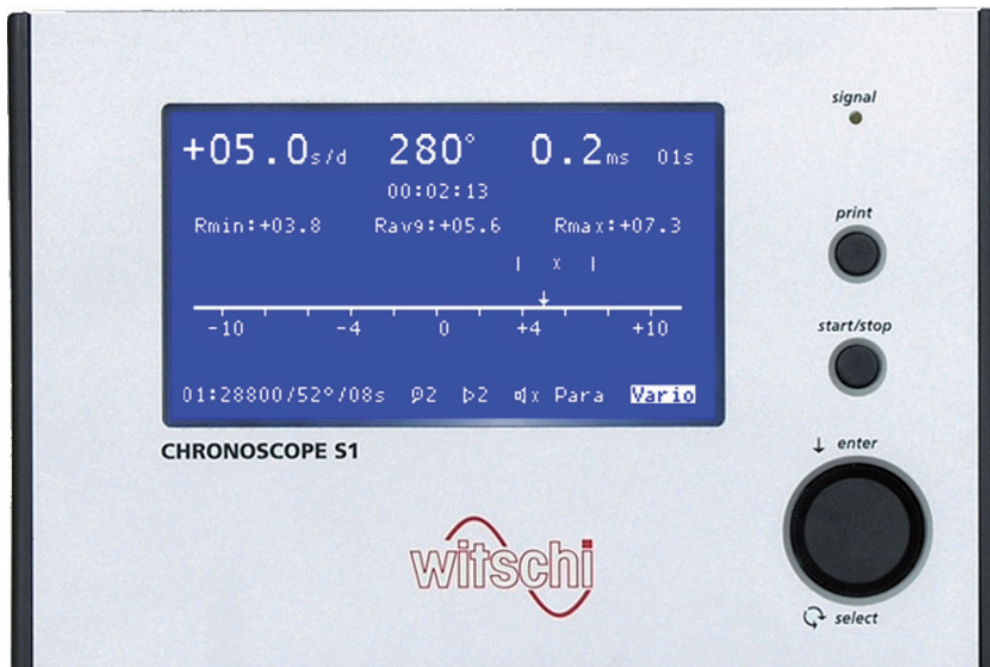

LCD Screen	<p>The screen with 240 x 128 pixel displays complete information, i.e. real time clock with date, parameter settings, system settings, diagrams, results, statistics, beat noises, calibration etc. Four different display modes are selectable:</p> <p>Cont Continuous diagram recording of the beat noise.</p> <p>Vario Rate and amplitude stability check over a longer time range, up to 100 hours.</p> <p>Scope Graphic display of the beat noises with adjustable time interval: 20, 200 and 400 ms.</p> <p>Seq Only with the optional Micromat S for automatic measuring cycle with 3 to 6 test positions.</p>
Rotary Knob	<p>Rotary knob for selecting measuring functions and setting up parameters. It has a twofold function: functions or parameters are selected by rotating the knob and activated by pressing it.</p>
print	<p>Key for printing out the numerical test results or: graphic printout of the screen content (print screen).</p>
start/stop	<p>Key for starting and stopping a measurement.</p>
signal	<p>LED showing the signal level.</p>

Parameter Setting

CALIBRE		MEASURE	
Program:	01/20	Measur.time:	20 s
Beat number:	Man 28800	Resolution:	0.1s/d
Test mode:	Stnd	*** Sequence ***	
Lift angle:	52°	Stabil VV/HH:	Aut s
		Stabil VH/HV:	Aut s
		Positions:	3V_2H
			Quit

CALIBRE	Setting	Description
Program:	01/20	20 program numbers are available (01/20 to 20/20).
Beat number:	Aut Man Sel Frq	Automatic selection of the most common beat numbers. Manual setting of less common beat numbers from the table. Any beat number between 3600 and 43200 can be set. This mode determines the frequency of an unknown watch.
Test mode:	Stnd Spe1 Spe2 Spe4 Rate	Mode for watches with standard Swiss lever escapement. Mode for watches with coaxial escapement Mode for watches with AP escapement Mode with specific amplitude filter. Only the rate measurement occurs. For watches with bad or unusual beat noises.
Lift angle:	xx°	The lift angle can be set from 10° to 90°.

MEASURE	Setting	Description
Measur. time:	Aut s xx s	Automatic selection of the measuring time by the beat number. The measuring time can set up between 2 and 240 s.
Resolution	s/d	Resolution for the numeric rate display, 1 s/d or 0.1 s/d.
Sequence		The sequential test mode only occurs if the automatic microphone Micromat S (optionally available) is connected.
Stabil VV/HH:	Aut s Man	Automatic selection of the stabilization time by the beat number. Manual setting of the stabilization time, between 1 and 99 s.
Stabil VH/HV:	Aut s Man	Automatic selection of the stabilization time by the beat number. Manual setting of the stabilization time, between 1 and 99 s.
Positions		Choose one of the 7 programmed default test sequences.

For more details please consult the instruction manual **Chronoscope S1**.

Error detection with graphical charts

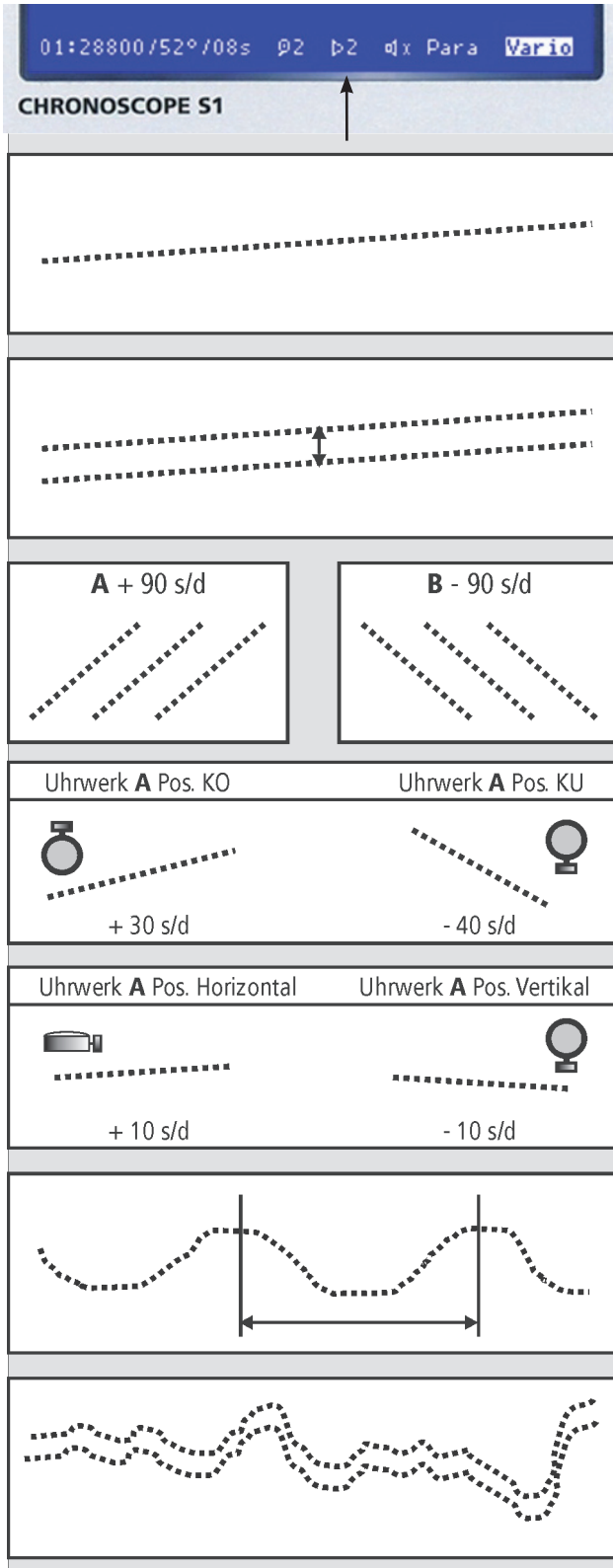

Amplification adjustment of the equipment:
2 is standard adjustment. If the chart appearance is disturbed, the signal amplification can be reduced or increased by means of the rotary knob.

Watch movement ok.
 Rate: +1 to +15 s/d
 Amplitude: H 250 - 330°, V 220 - 270°
 Beat error: 0.0 to 0.5 ms.

Watch movement ok.
 Beat error: to high (approx. 3 ms)
Action: adjust first the beat error, and then readjust the rate accuracy.

Watch movement ok.
 Movement **A**: runs too fast
 Movement **B**: runs too slow
Action: readjust the rate, +2 up to 15 s/d.

Watch movement with large rate variations between different vertical test positions.
Action: centering, balancing or replacing of the complete regulating organ.

Watch movement with little rate variations between the horizontal and vertical test positions.
Action: adjust distance of regulator pins, for V - close pins and for V + open pins.

Watch movement with large, but regular rate variations:
 defects in the gear train
Action: revision and eventually replacement of some gear train spare parts.

Watch movement with irregular rate and defects. Usually the amplitude is insufficient.
Action: overhaul.

Error detection with graphical charts

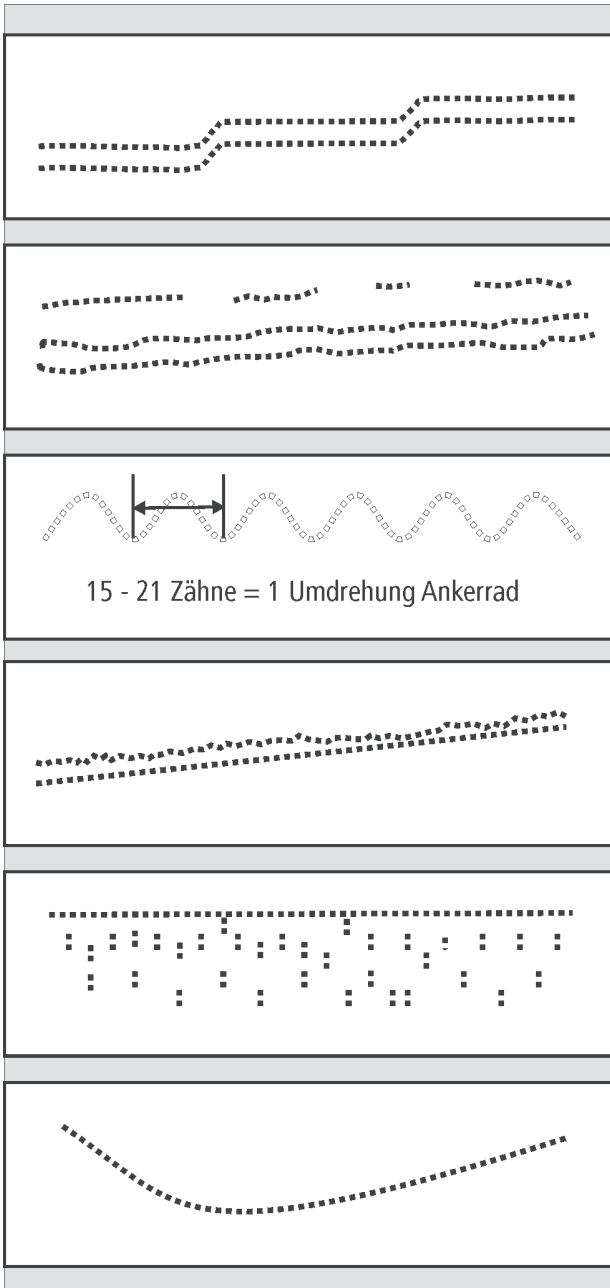

Balance wheel "knocks" occasionally. The cause is a too high amplitude (<math><330^\circ</math>). Audibly in the loudspeaker as double "tic-tac".

Action: replace mainspring, pallet-stone and/or escape-wheel.

Balance wheel "knocks" continuously. The cause is a too high amplitude (<math><330^\circ</math>). Audibly in the loudspeaker as double "tic-tac".

Action: replace mainspring, pallet-stone and/or escape-wheel.

Escape-wheel runs untrue.

Action: replace escape-wheel.

Entry pallet clips poorly or is smeared.

Action: clean the escapement or replace escape-wheel.

Hair spring touches. Usually the hair spring touches the regulator pins or the stud (audibly scratch noises in the loudspeaker).

Action: centre hair spring, adjust rate.

Slow oscillating of the balance wheel after changing a position. Bearing for balance wheel and gear train are badly or not lubricated.

Action: clean and lubricate, ev. overhaul.

Watch type	Rate in s/d	Amplitude H *	Amplitude V *	Beat error
Gent's watch	-5 to +15	250° to 330°	250° to 270°	0.0 to 0.5 ms
Lady's watch	-5 to +25	250° to 330°	250° to 270°	0.0 to 0.5 ms
Chronometer	-2 to +6	250° to 330°	250° to 270°	0.0 to 0.5 ms
Chronograph	-5 to +15	250° to 330°	250° to 270°	0.0 to 0.5 ms

* Values when movement is wound up. Decrease of the values after 24 h: approx -10% to -15% is ok.

Error detection with the Scope function

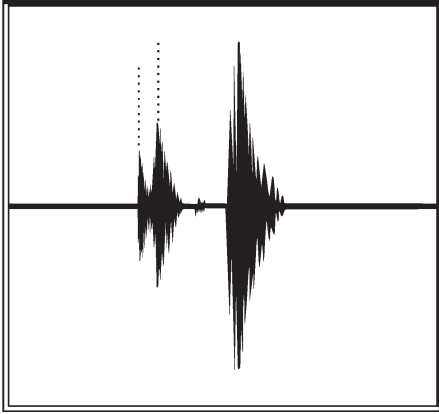

Escapement fitting to weak

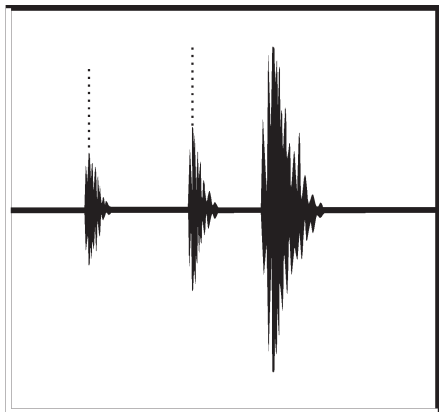
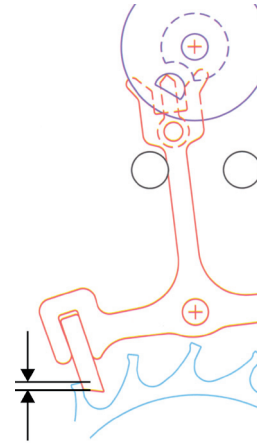

Escapement fitting to strong

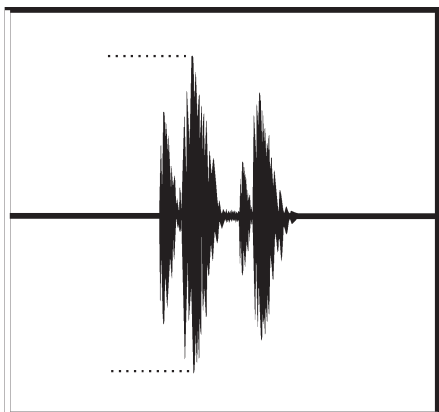
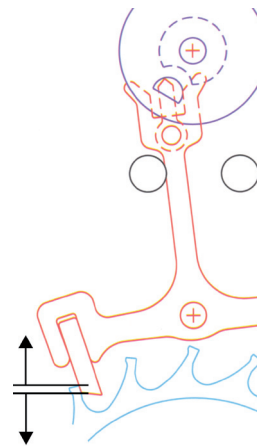

Unlocking to strong

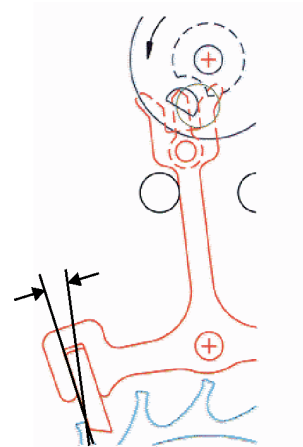

Error detection with the Scope function

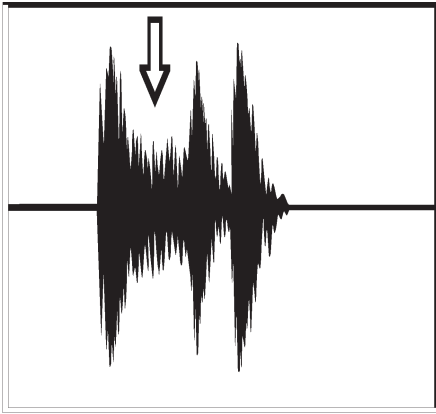

Additional friction

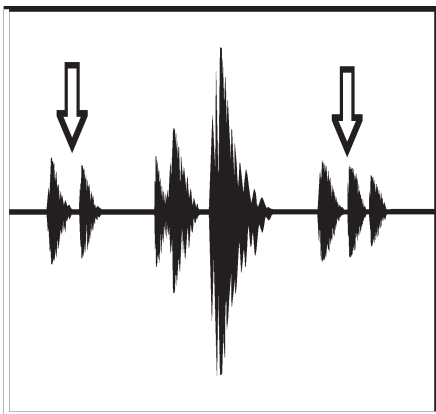
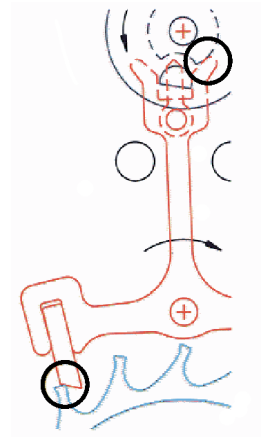

Dart touching the roller

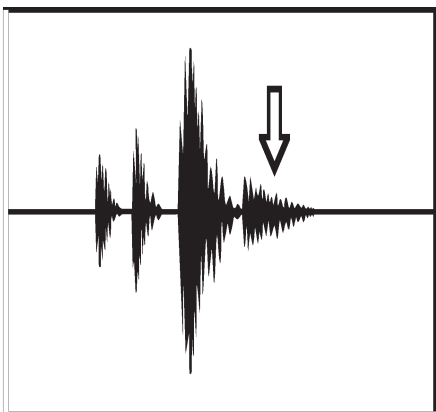
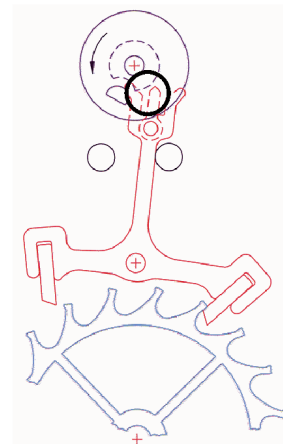

Not enough clearance between horns and the impulse pin

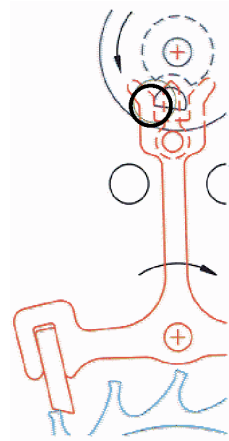

Error detection with the Scope function

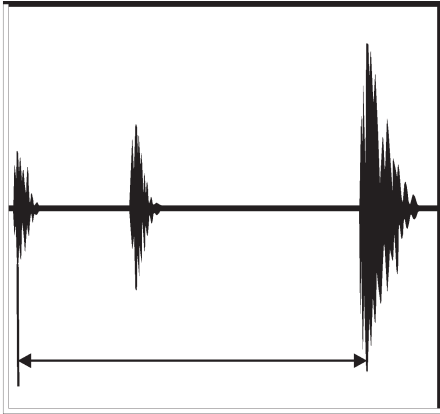

Weak amplitude

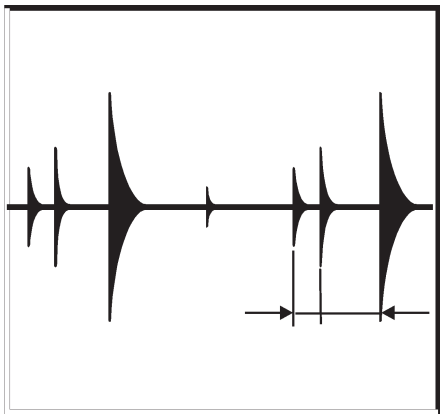

To much axial end shake in the pivot of the balance wheel

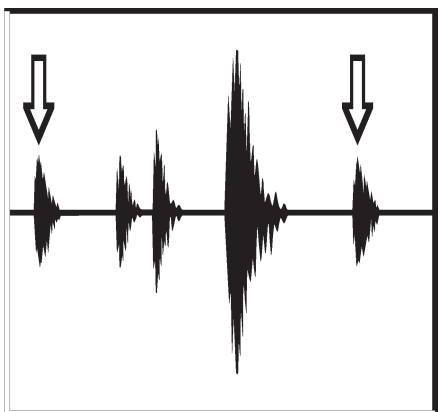
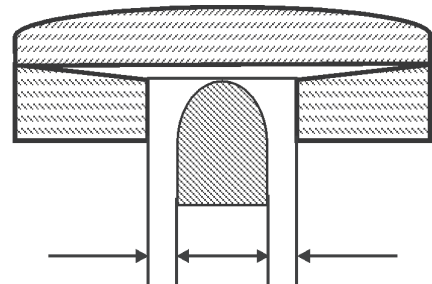

Fork horn touches the impulse pin (knocking)

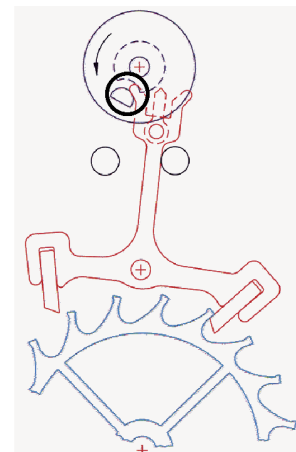

Error detection with the Scope function

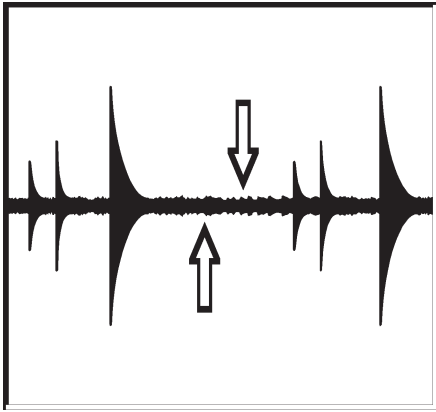

Rough pivot of the balance wheel's staff
uneven pivot or pivot's seizure

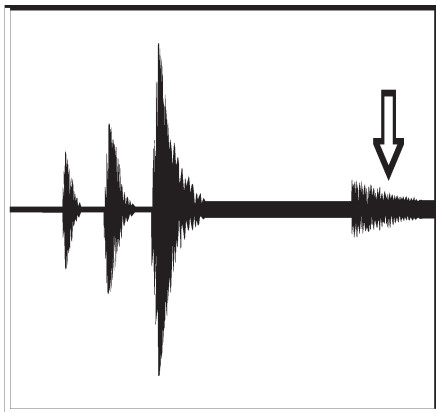
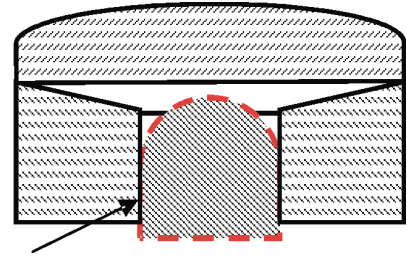

Grazing balance wheel / hair spring

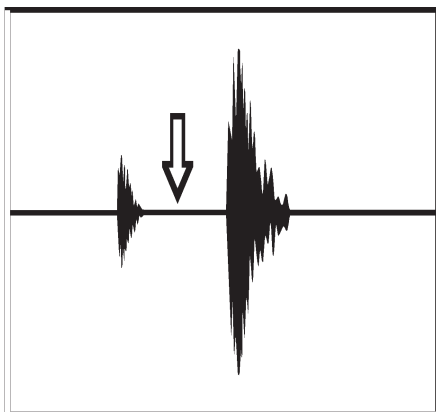
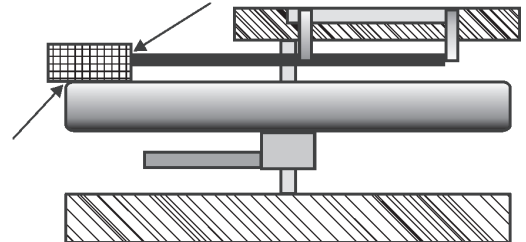

A tooth of the escape wheel penetrates
directly into the impulse plane

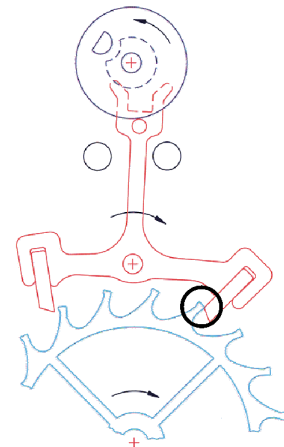

Quartz Watches Testing Methods Operating the Analyzer Q1



Battery

Assembly of a Silver Oxide Cell Zn/Ag₂O (cutaway).

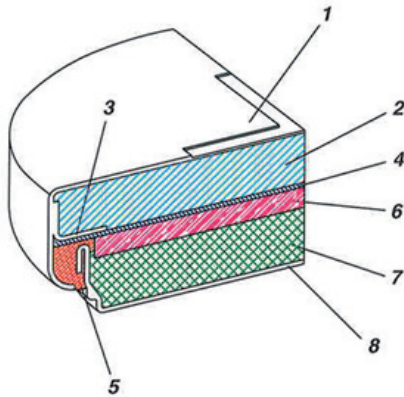

- 1 Can
- 2 Cathode (Ag₂O)
- 3 Support ring
- 4 Separator
- 5 Gasket
- 6 Electrolyte (NaOH / Sodium or KOH / Potassium)
- 7 Anode material (Zn)
- 8 Anode cap

Capacity dependence on temperature

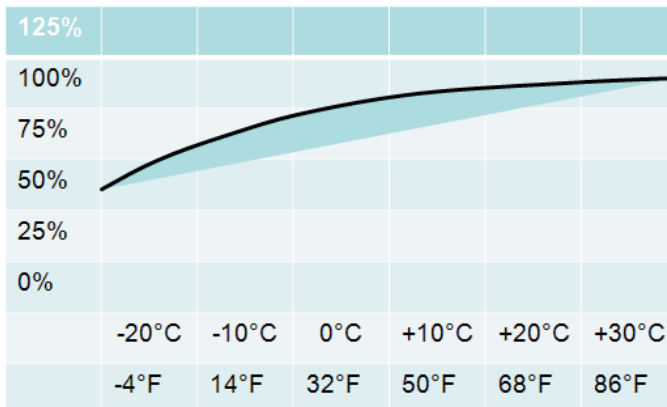

Example

Typical temperature effect of small-sized silver oxide batteries.

Self discharge rate at different storage temperature

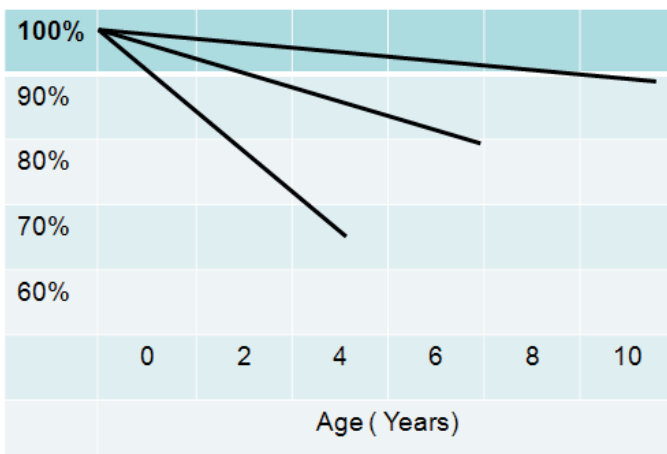

Nominal Capacity in mAh (100%)

minus 7-8% after 10 years at 0°C / 32°F
 minus 15% after 7 years at 20°C / 68°F
 minus 30% after 4 years at 40°C / 104

High Drain and Low Drain Battery

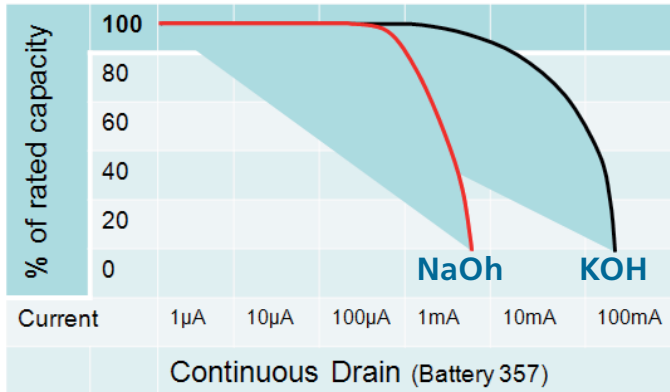

Efficiency (voltage drop)

Low Drain Battery with NaOH (Sodium) Electrolyte.

High Drain Battery with KOH (Potassium) Electrolyte.

Quartz

Construction

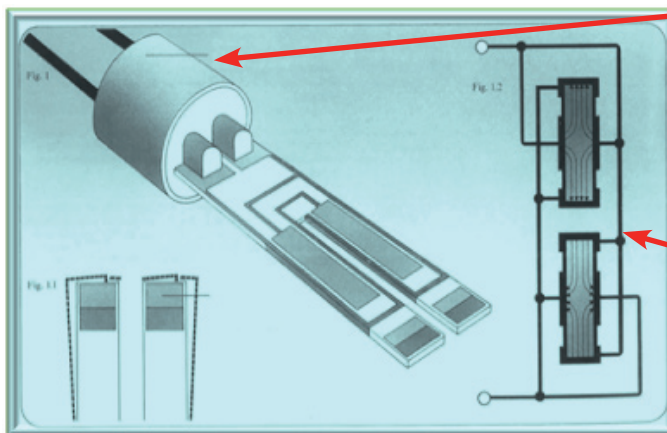

Shows typical tuning fork quartz used for quartz watches on the base of its container. Its two branches are animated by an anti-parallel oscillatory movement (flexion) in the plane of the tuning fork.

Represents a section of the branches of the tuning fork. It shows how the electrodes are connected, as well as the electric fields which are formed inside the crystal.

Technical Features

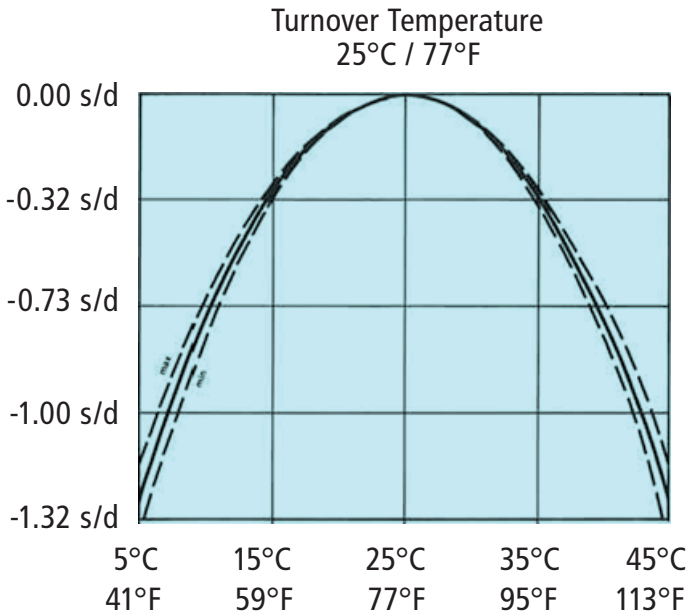

Frequency response to the temperature

If the watch is worn on the arm, the temperature inside the watch is about 28°C / 82.5°F.

Conclusion

If the quartz frequency can be adjusted by the out dated systems with trimmer, the rate at room temperature should be set to about + 0.15 s/d.

Integrated Circuit (IC)

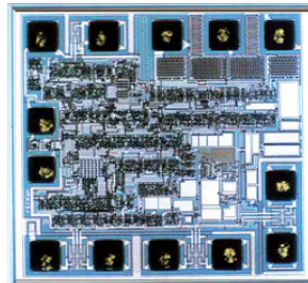

Rate Adjustment Systems

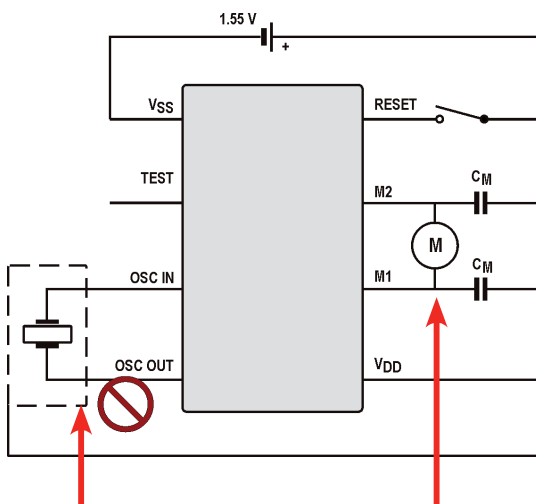

Trimmer system

The oscillator frequency is adjustable by trimmer. Rate measurements through the oscillator frequency or through the motor pulses show the same result (out dated system).

Rate Adjustment Systems

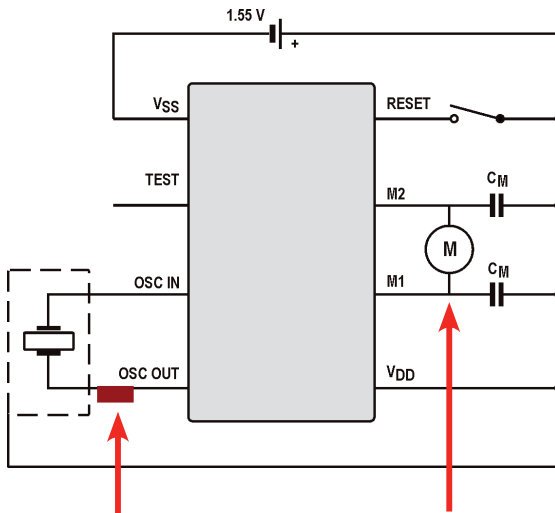

Fix cap system

The oscillator frequency is adjusted by a fix cap during the production process. Rate measurements through the oscillator frequency or through the motor pulses show the same result.

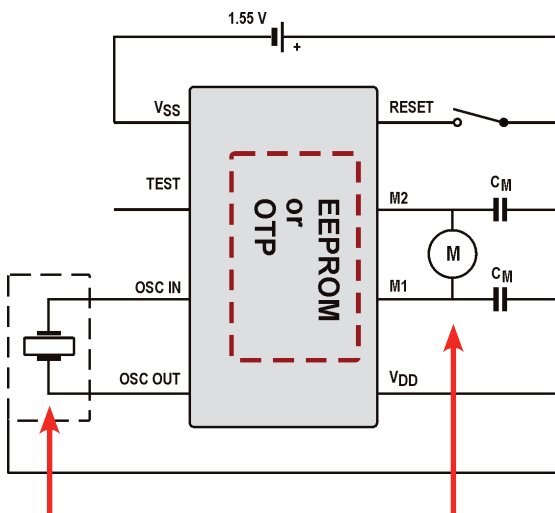

Inhibition system (digital adjustment)

The quartz oscillator frequency is not adjustable (no trimmer or fix cap). The frequency divider suppresses a programmable number of pulses of the quartz oscillator during an inhibition period. Adjustment occurs during the production process. After the elapsed inhibition time, rate measurements through the oscillator frequency or through the motor pulses show **different** result.

Programming systems:
 EEPROM - Re-programmable.
 OTP - One time programmable.

Step Motor

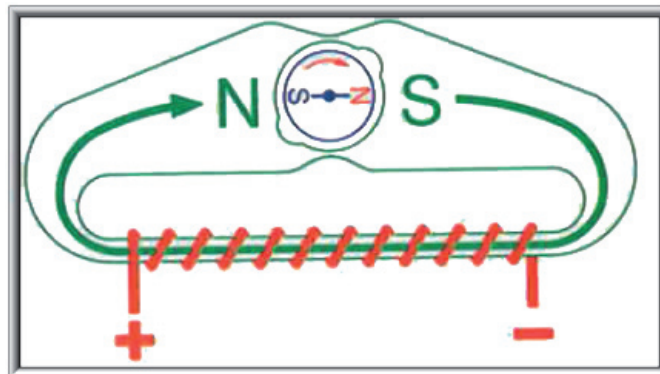

Motor Management Systems

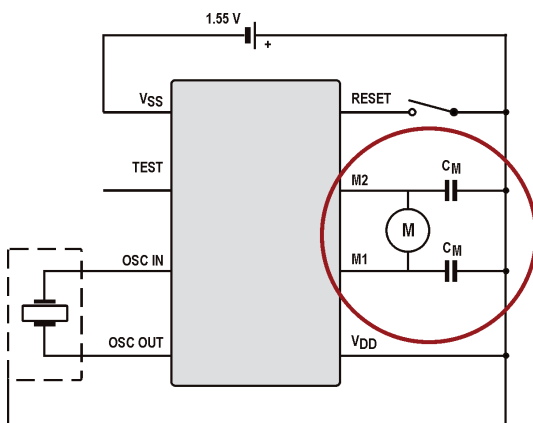

IC without adaptive motor pulses

The step motor is driven by bi-polar pulses with constant pulse width. The pulses are not chopped (no asservissement). IC type which is mainly used for low cost quartz watch movements.

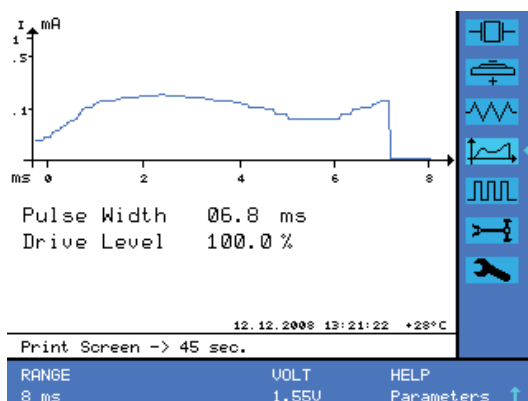

Motor Management Systems

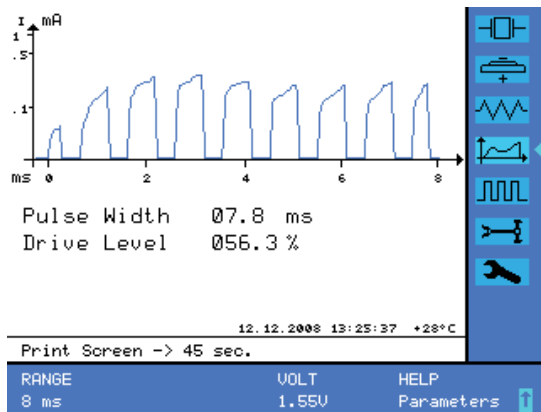
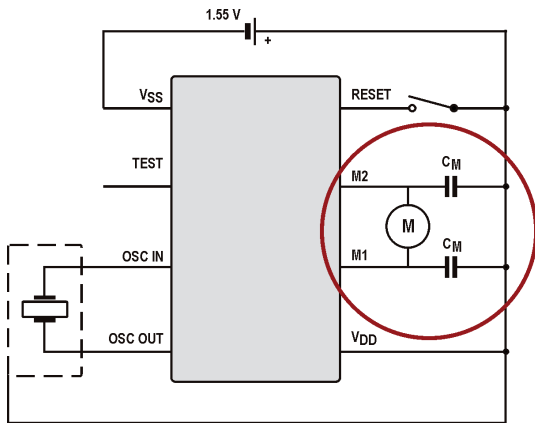

IC with chopped motor pulses

The step motor is driven by bi-polar pulses with adaptive motor pulses (asservissement). The two way controlled power management is adapting continuously the chopping rate.

It reduces the energy consumption for the mechanical drive. Thus, the battery life can be extended.

IC type which is mainly used for high quality quartz watch movements.



Motor drive stage

Adaptive bi-polar motor pulse, schematically



Typical motor pulse form

Detection phase.

Motor Management Systems

Chopped motor pulses - Functional principle

The power management of the IC is adapting the chopping rate according the power request of the step motor.

Below the graphical representation of an example. Pulse width = 6.8 ms, Pulse period = 1 s.

Steps:

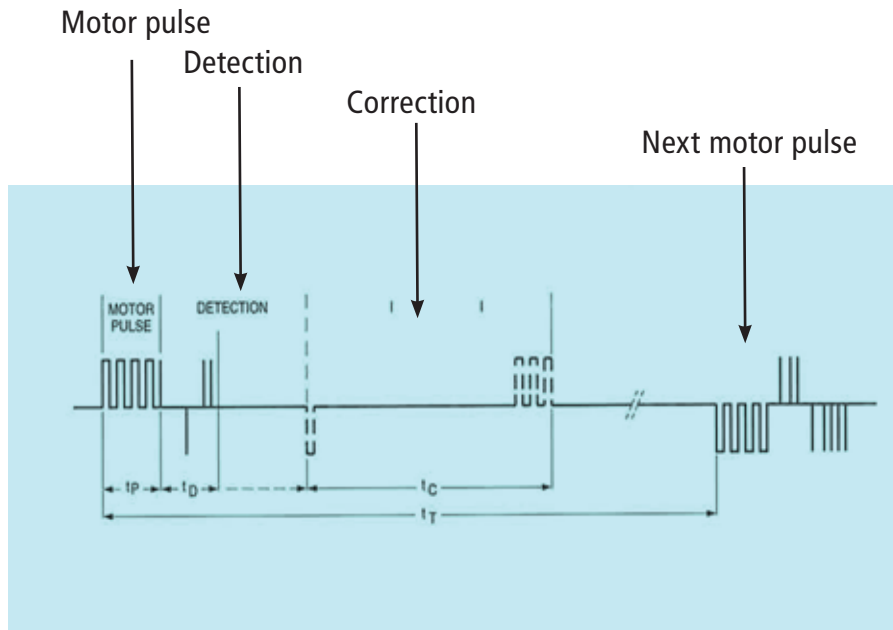

Drive level:

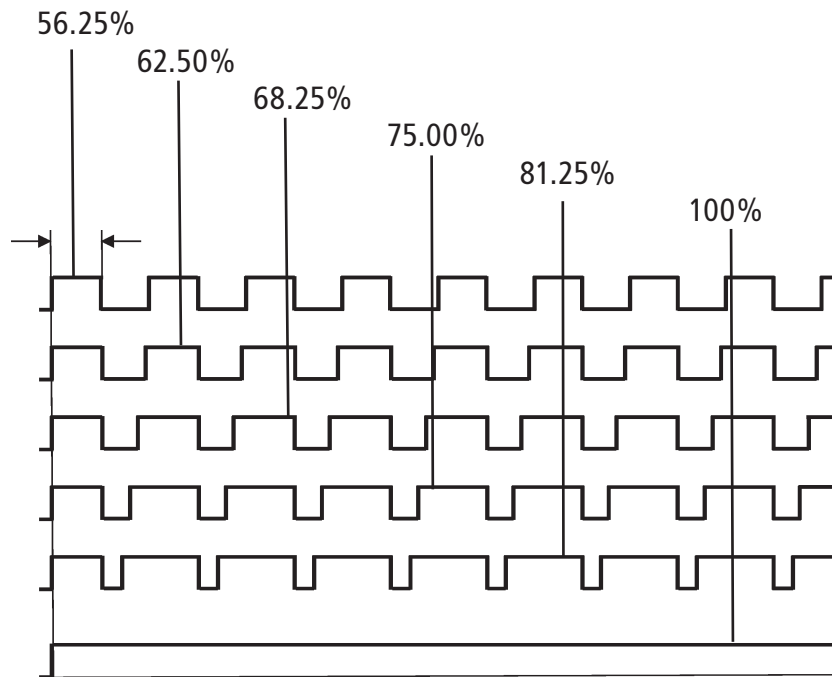

View

Part

Characteristics

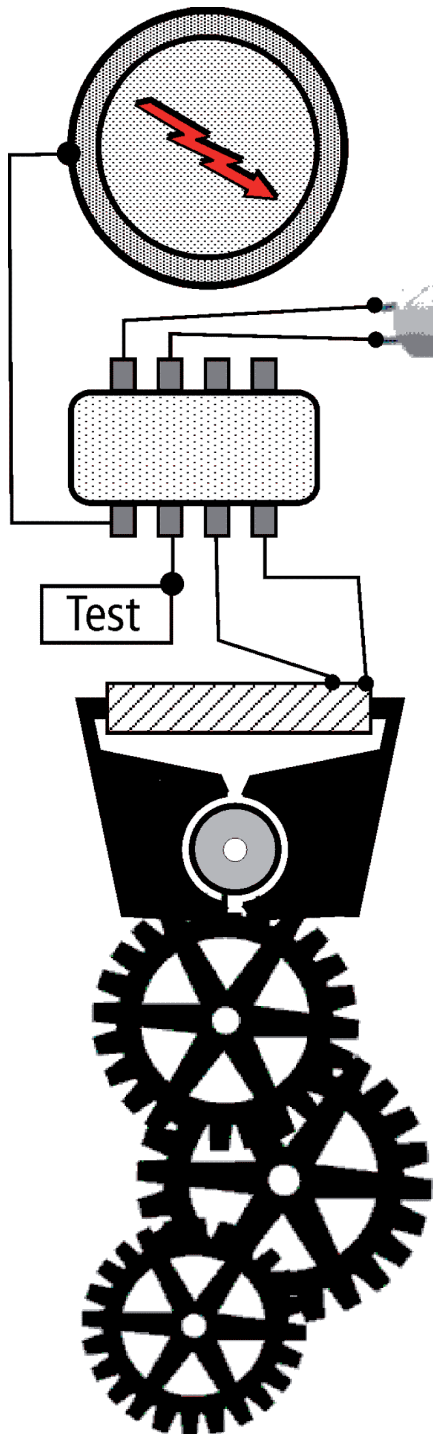

Battery

The **energy storage device**

Quartz resonator

The quartz resonator (SiO₂) oscillates usually with 32768 Hz. Together with the IC it forms a precise oscillator and constitutes the regulation organ of the quartz watch.

Integrated Circuit

The **IC** fulfills various functions, e.g.:

- quartz oscillation circuit
- frequency divider to 1 Hz or less
- digital rate adjustment (inhibition)
- adaptive chopping level
- other functions such as chrono, alarm etc.

Stepping motor

The **stepping motor** (coil, stator, rotor) converts the current pulses into a rotary motion.

Gear train / hand train

Moves the hands, the calendar and **other mechanical** functions.

All rate measurements of quartz watches are based on the acquisition of following signals:

Analogue or analogue/digital quartz watches

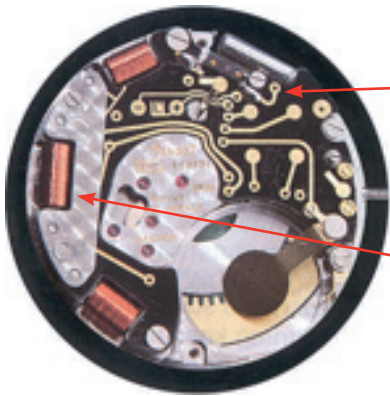

Quartz frequency
Acoustic or capacitive

Stepping motor
Inductive (magnetic)

Digital quartz watches

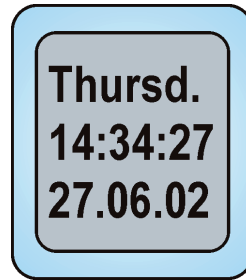

Quartz frequency
Acoustic

Working freq. of LCD display.
Capacitive on the **glass**: 4, 8, 16, 32 or 64 Hz.

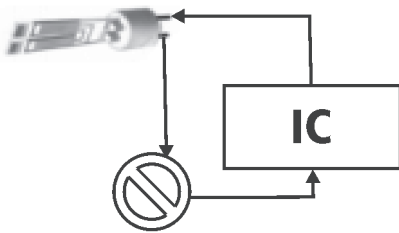

The measurement of the **quartz frequency**, (32768 Hz) occurs over the **acoustic** or the **capacitive** sensor. For the rate adjustment 2 different methods are usually used:

A Adjustment of the quartz oscillator frequency with a trimmer (out dated) or a capacitor (fix cap). The real rate measurement can occur over the quartz frequency or magnetically over the motor pulse.

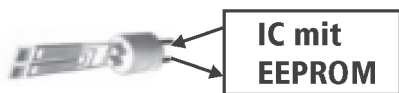

B The quartz oscillator frequency is not compensated (no trimmer). The frequency divider suppresses a programmable number of pulses of the quartz oscillation during an inhibition period, i.e. they are not forwarded to the next divider stage. The usual inhibited periods are 60s (for some IC's 20s, 30s or every 2, 4 and 8 minutes for precision watches). **The measurement time must be an inhibition period or a multiple thereof.**

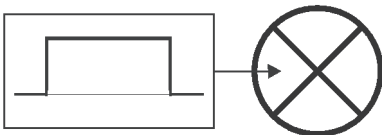

The **motor pulses** are picked up inductively over the magnetic sensor.

The stepping motor is driven with pulses like:

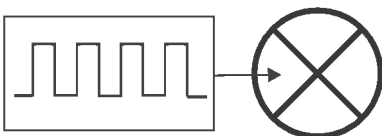

Pulses with constant or variable pulse length.

Chopped pulses with constant pulse width, which are continuously adapted to the watch movement's condition for a lower current consumption.

Operating Elements and Display Panel

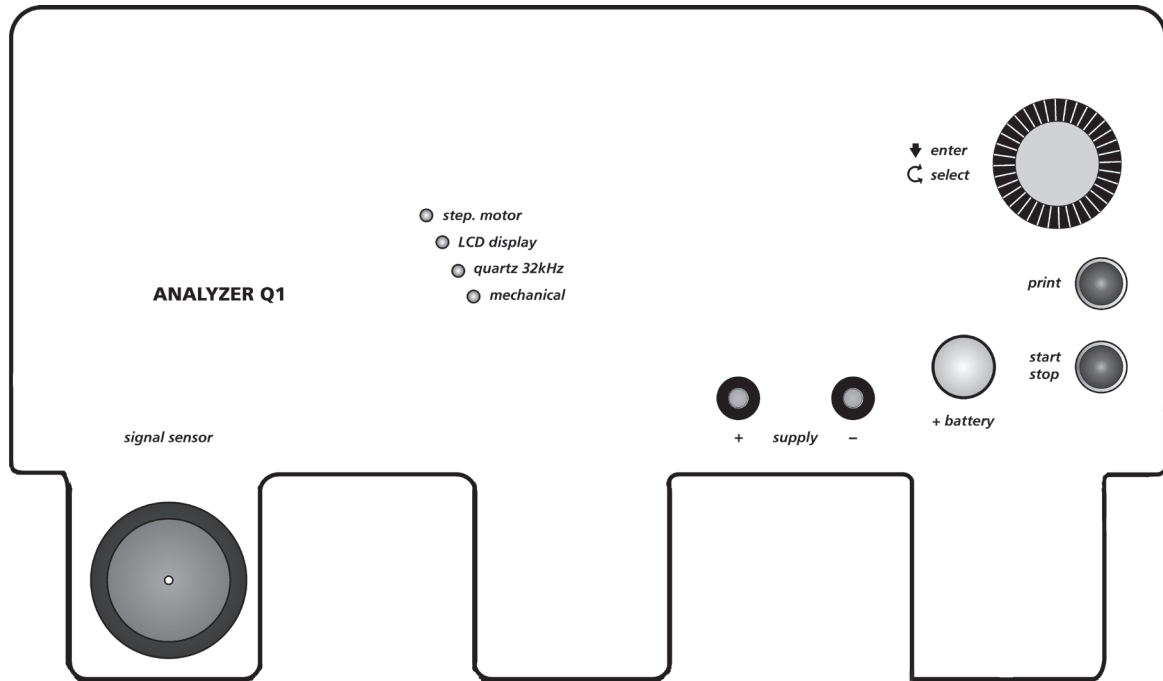

signal sensor	Signal transducer for capacitive, magnetic and acoustic signals.	
↓ enter ↻ select	Rotary knob for selecting measuring functions and setting up parameters. It has a twofold function: functions, parameters or information are selected by rotating the knob and activated by pressing it. Short pressure on the knob Activates the selected function or parameter settings.	Long pressure on the knob Back to main menu.
print	Short pressure on the knob Current results printed as measurement log.	Long pressure on the knob Screen content printed as graphic image.
start/stop	Key for starting and stopping a Measurement	
	Short pressure on the knob The current measurement is stopped and restarted.	Long pressure on the knob The measurement is stopped until it is restarted by pressing the key.
battery +	+ battery support for the battery test.	
+ supply -	Connection for direct supply of modules or watch movements with two movable contact probes.	

Operating Elements and Display Panel

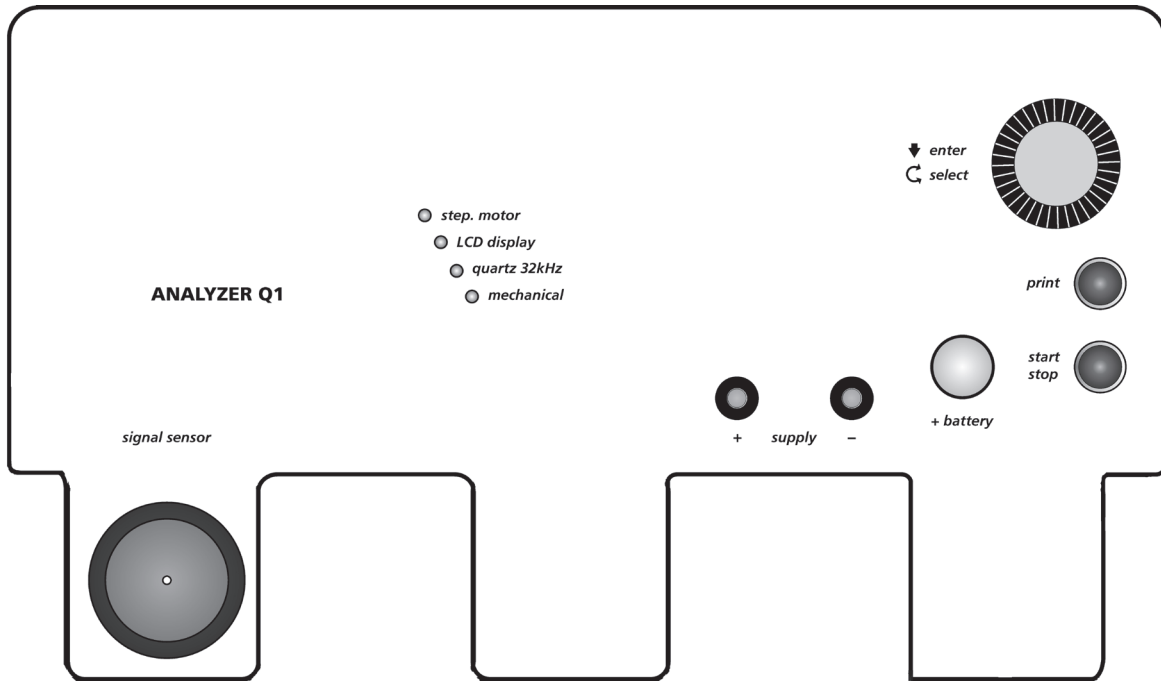

LED's

<i>step. motor</i>	Signal level of the motor pulses, signal acquisition magnetic or through the supply current.
<i>LCD display</i>	Signal level of the LCD signal (capacitive).
<i>quartz 32kHz</i>	Level of the 32kHz quartz signal: acoustic, capacitive or through the supply current.
<i>mechanical</i>	Signal level of the watch noise (acoustic).

Operating Elements and Display Panel

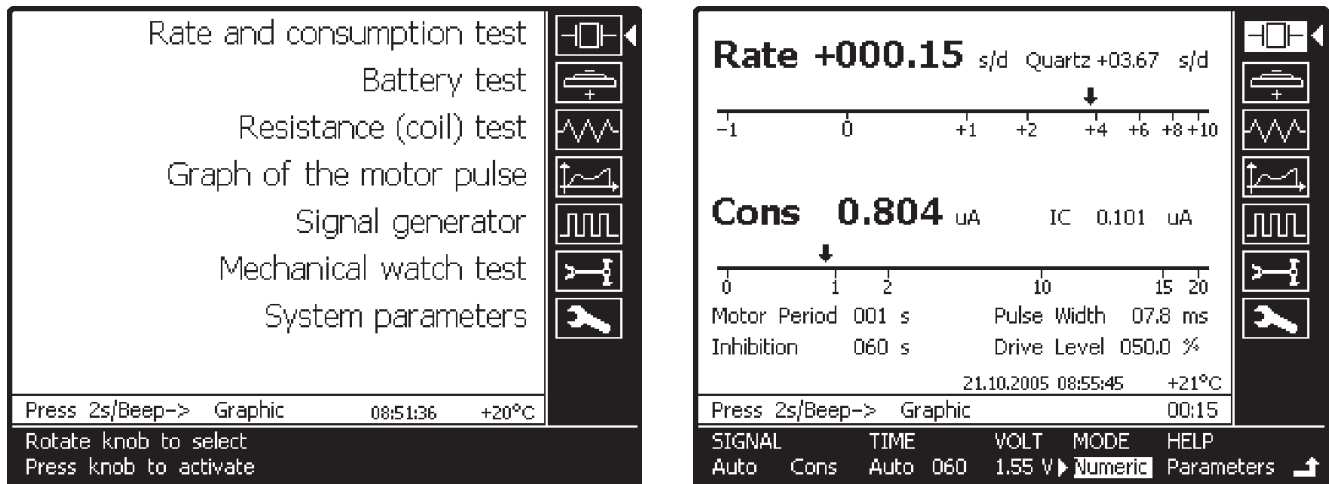

Display Panel

The display panel, which can be tilted to the best viewing angle, is equipped with a back lighted 1/4 VGA LCD graphic screen (320 x 240 dots).

The display is divided into several fields:

- The right hand bar contains the symbols for the miscellaneous measurement functions. The selected function has a white background and is indicated by a white arrow.
- The parameters and information belonging to the selected function are displayed on the lower horizontal bar and can be selected there. The selected parameter has a white background and blinks.
- The current numerical and graphic results are displayed on a white background in the result field. This field also contains information or parameter depending on the selected function.
- An information line under the result field contains information on the current measurement.

For more details please consult the instruction manual **Analyzer Q1/Twin**.

Watch tests with built in battery

Quartz + IC Test

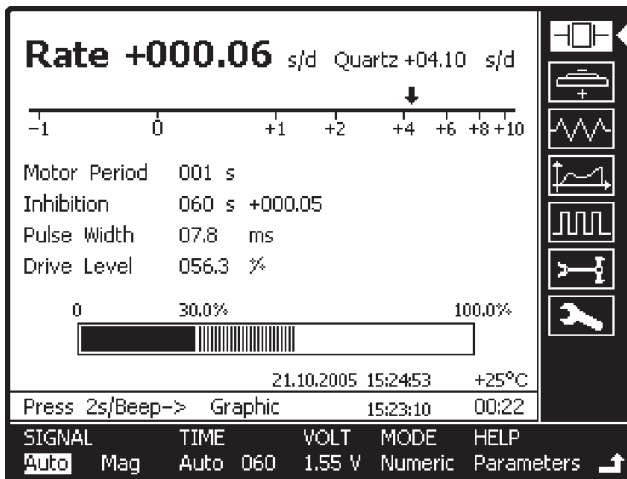

Short test of the quartz signal

- 1 Select **Rate and consumption test** in main menu.
- 2 Place the watch on the *signal sensor*
- 3 Set SIGNAL to **Auto** or **Quartz**
- 4 Set TIME to **Auto**

Test is OK if:

- 5 LED *quartz 32kHz* lights up.
- 6 Rate Quartz is displayed (+0.0 to +6 s/d).

Motor Test & Rate Accuracy

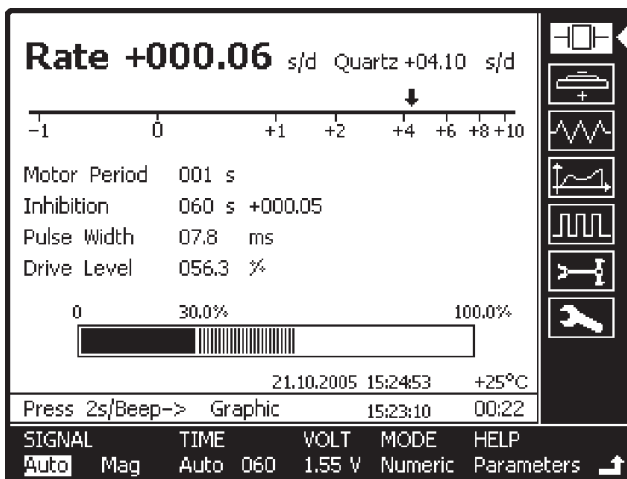

Through the motor pulses

- 1 Place the watch on the *signal sensor*
- 2 Set SIGNAL to **Auto**
- 3 Set TIME mode to **Auto**
The adequate measuring time is automatically selected.

Test is OK if:

- 4 LED *step. motor* blinks in the rhythm of the motor pulses.
- 5 After the elapsed measuring time a rate of +0.0 to +0.5 s/d is displayed.

Watch tests with external power supply

Rate and consumption measurement

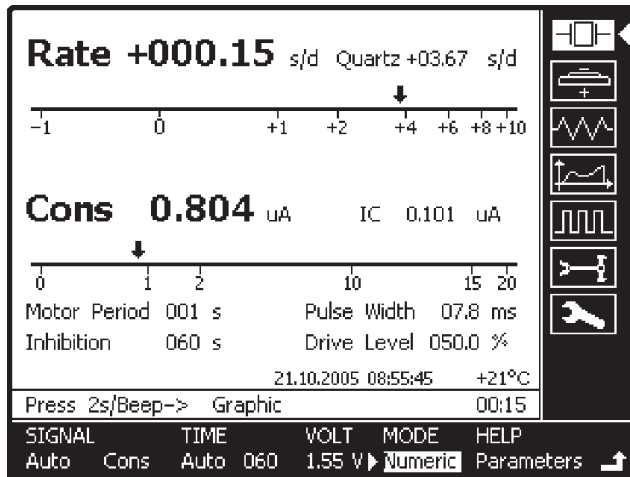

Procedure

- 1 Place the watch on the **mirror place** and connect both battery connectors to **+ supply** - with the movable contact probes.
- 2 Set VOLT to **1.55 V** or another voltage value according to the watch's battery voltage.
- 3 Set SIGNAL and TIME modes to **Auto**
- 4 LED **quartz 32kHz** lights up.
- 5 Rate Quartz is displayed (0 to 6 s/d).

Motor Test & Rate Accuracy

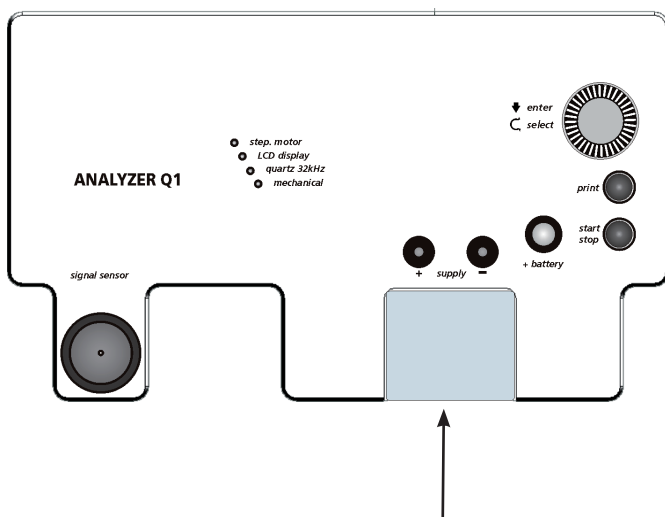

Procedure

- 1 Place the watch on the **mirror place** and connect both battery connectors to **+ supply** - with the movable contact probes. If accessible, contact also the RT/T test point of the IC with **- supply**. This will enable the accelerated test mode.
- 2 Set VOLT to approximately **0.50 V**
- 3 Observe the watch hands in the mirror. Increase slowly the supply voltage with the rotating knob, until hand starts moving.
- 4 The displayed power voltage is called **Minimum operating voltage**.

Tests of Battery and Components

Battery test

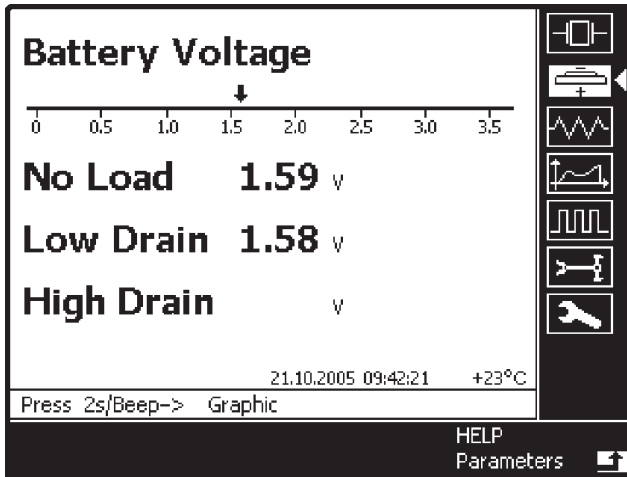

High Drain voltage

Good battery: higher than 1.25 V
 End of lifetime: below 1.20 V

Test of Coil resistance and insulation



Procedure

- 1 Select **Battery test** in main menu.
- 2 Place the battery on the + **battery** support and contact the bottom side of the battery with the - (black) movable contact probe.
- 3 The device automatically detects that a battery has been connected and a load of 2 kΩ is switched on, once per second for 10ms.
 For high drain batteries briefly press the start button; this will switch on the load of 100 Ω for 1 s.

4 Silver oxide batteries: typical values

No Load and **Low Drain** voltage
 Good battery: 1.45 to 1.6 V
 End of lifetime: below 1.40 V

Lithium batteries

Typical No Load and Low Drain voltage
 Good battery: 2.9 – 3.2 V
 End of lifetime: below 2.8 V

Procedure

- 1 Select main menu **Resistance (coil) test**
- 2 **Coil Test.** Contact connectors (**M**) with test tips. Normal value: approx. 1 to 2.5 kΩ
- 3 **Coil Insulation.** Contact one coil connector and the plate (**P**). Normal resistance values: approx. **700 kΩ to x MΩ**
- 3 **Movement Insulation.** Contact plate (**P**) and the - Battery terminal (**-B**). Normal resistance value: approx. **700 kΩ to x MΩ**

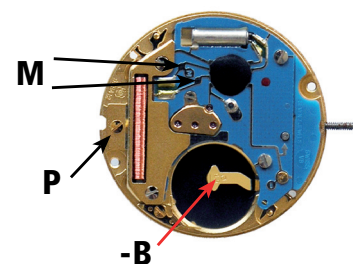

Step Motor Test with Pulse Generator

The step motor and the mechanical part of quartz analogue watch can be tested with the signal generator, independently of the electronic circuit. The step motor can be accelerated for detecting quickly mechanical faults such as hands catching each other or problems with the change of date etc.

Pulse Generator

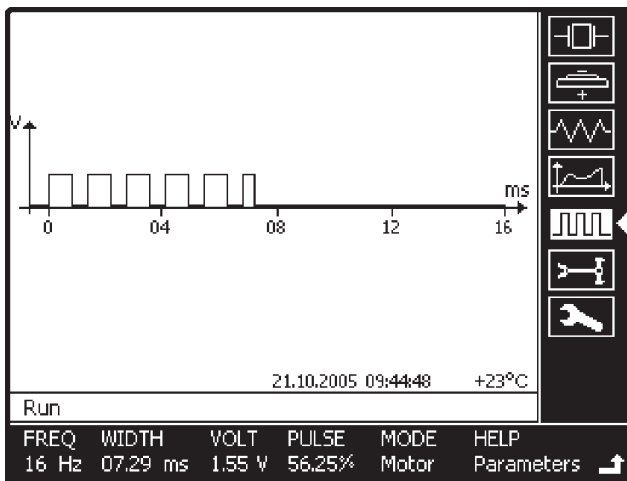

Procedure

- 1 Select **Signal generator** in main menu.
- 2 Set MODE to **Motor**
- 3 Set WIDTH and PULSE values according to the data needed for testing.
- 4 Remove the battery and contact the motor coil with the movable contact probes.
- 5 Set the VOLT parameter to approx. **0.5 V**. Increase slowly the voltage with the rotating knob, until hand starts moving. The movement should run with voltage of **below 1.35 V**.
- 6 According to the manufactures data the test may also takes place with different parameter settings of the pulse width and/or chopping levels.

Buzzer Test

The device provides a bipolar test signal with adjustable voltage and a fixed frequency of 2 kHz.

Pulse Generator

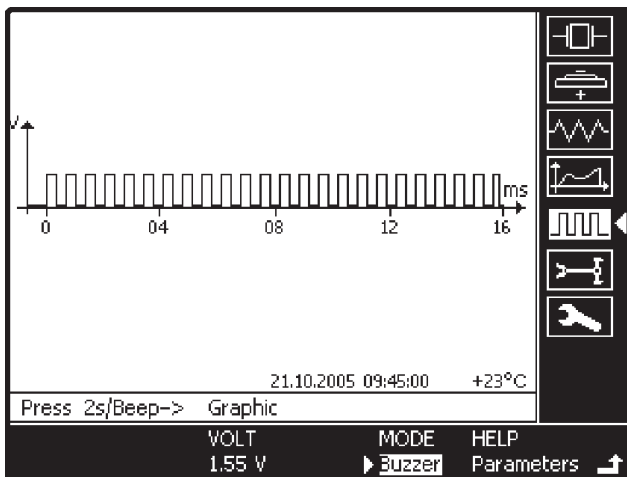

Procedure

- 1 Select **Signal generator** in main menu.
- 2 Set MODE to **Buzzer**
- 3 Set the VOLT parameter to the value according to the data needed for testing.
- 4 Connect the wiring points of the buzzer with the movable contact probes or the test tips.
- 5 If the alarm sound is easily heard, then the acoustic transmitter is o.k.

Graph of the Motor Pulse

The Analyzer Q1 can record the motor current pulse as an oscillogram. In addition to the pulse parameters, the shape of the current pulses provides additional information on the state of the watch.

In particular, faults can be detected in the mechanical part of the watch by comparing its measurement to those of a watch of the same type in good condition.

The pulse width and the chopping level (drive level) are displayed in numerical form.

Pulse Analysis

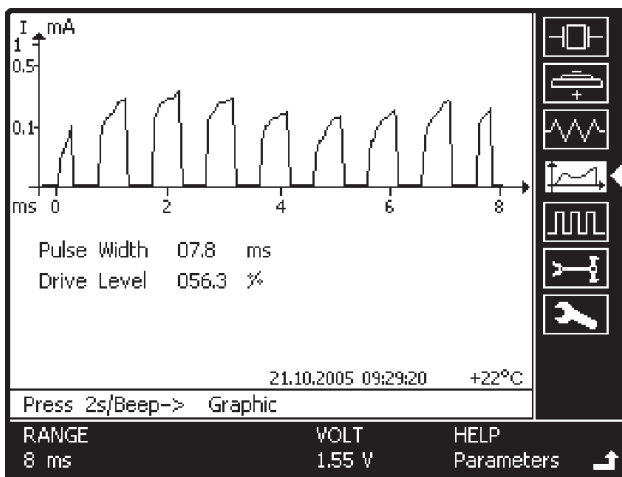

Procedure

- 1 Select **Graph of the motor pulse** in main menu.
- 2 Supply the watch with the device and set the VOLT parameter to the watches' nominal voltage, mostly **1.55 V**.
- 3 Set the RANGE parameter according to the pulse width.
- 4 The voltage can be changed with the VOLT parameter, e.g. for testing the watch under reduced supply voltage.

The Watch stops running

Check	Cause / Troubleshooting
<p>Battery Check the battery voltage. Check always the battery sealing and its emplacement, if salt crystals have grown.</p>	<p>Battery is defect Clean the battery emplacement. Insert a new battery.</p>
<p>Motor Coil Check the coil resistance and the insulation.</p>	<p>Motor Coil is defect Replace the coil. When the coil is firmly attached to the module, then the entire electronic module must be replaced.</p>
<p>Oscillator and IC Check the rate accuracy, consumption and consumption in reset mode (stem is pulled out).</p>	<p>No signal for rate measurement is detected IC or quartz oscillator is defect: electronic module must be replaced. Reset mode is not functioning Check if the reset function exists. If yes, check and clean the mechanism.</p>
<p>Step Motor Supply movement with the nominal voltage. Check the Reset function when pulling the stem.</p>	<p>Step Motor is not rotating Check if: - steel particles block the rotor/gear train - particles between crown and case block the reset mechanism - hands touch the inside face of the glass - hands have no axial side shake Depending on the check results: - remove particles and clean the mechanical parts - readjust the horizontal position of the hands - clean the hand-fitting mechanism / evtl. some parts must be replaced</p>
<p>Starting Voltage Reduce the supply voltage until the watch stops or reverse until the watch runs.</p>	<p>Starting voltage is to high Proceed as above.</p>

Tightness Test Testing Methods Operating the Proofmaster S



Standards for the tightness test

Standards for all definitions, test methods, minimum and maximum values, etc.

ISO 6425

Watches labeled as **"Diving Watches"** must be tested in accordance with this standard.

ISO 22810

Watches labeled as **"Water Resistant"** must be tested in accordance with this standard.

The label on wristwatches which meet the requirements of this standard must only contain a single expression per language:

in German: Wasserdicht

in French: Etanche

in English: Water Resistant

Convenient aspects of the label "Water resistant"

Watches which are designated as water resistant must be imperishable as follows to sweat, water drops, rain and to immersion into water:

- at a depth of 10 cm (over pressure of 0.01 bar) for 1 hour.
- at a depth of 20 meters (over pressure of 2.00 bar) for 10 minutes.

Minimum requirements (standard converted to air pressure tests)

A watch fulfils these requirements if:

The **air penetration into the watch** under a pressure of **2 bar** does not **exceed 50µg** (microgram) **per minute**.

Deformation principle - Reference to ISO Standard 22810

The ISO 22810 standard does not take into account the volume of the watch. Therefore, the leak rate value of 50 µg/min. is valid for all watches irrespective of their size. In the test according to the deformation principle (PROOFMASTER S/M), the deformation reversal depends on the free volume in the watch. A watch with a smaller volume shows a greater deformation reversal for the same quantity of inflowing air. For a test in accordance with the standard, it is necessary to program the water-resistance limit according to the free volume in the watch. The approximate values are -0.5%/min. for large watches, -1%/min. for medium watches and -2%/min. for small watches.

Precautions in use

To safeguard the characteristics of the watch for an extended period, knowing that water resistance is not a definitive and acquired characteristic, the user is advised to:

- arrange for the water resistance of the watch to be checked by an expert, following the manufacturer's recommendations and in every case the watch has been opened. In this case, it is recommended to perform the air pressure test,
- make sure on purchasing that the bracelet is suitable for the intended use,
- avoid exposing the watch to excessively sudden temperature variations,
- preserve the watch against falls and shocks (arrange for the water resistance to be checked after every violent shock),
- refrain from using the control elements, push-pieces or time-setting crown under water and outside water when the watch is not dry,
- replace securely and screw on (if applicable) the time-setting crown and the push-pieces after every operation,
- rinse the watch in fresh after use in sea water.



Test Methods

Three main methods are used for the tightness test in watch manufacturing and after sales service.

Differential pressure principle (volume comparison)

Following values are determined by performing the calibration cycle:

1st measurement: Entire volume of test chambers without watches

2nd measurement: Volume of the watches

Result: Remaining free space in test chambers

During the test cycle, the device monitors the variation in the calibrated remaining free space and determines on this basis whether the watches are tight or not.

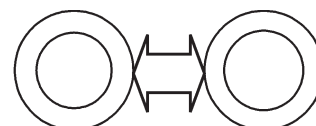

Field of application: ideal for series production
(not suitable for the watch service).

Deformation principle (Proofmaster S)

A defined pressure and/or vacuum is created in the test chamber. The watch undergoes a deformation due to the elasticity and material property of the watchcase.

The sensor system of the device tracks the deformation of the watchcase during the whole test cycle. From this the device determines, if the watch does or does not correspond to the set "water resistant" tolerances.

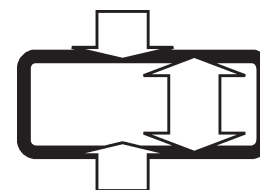

Field of application

Small series production, repair shops and retail business.

Condensation test

The Watch is first tested under pressure in water, then brought to a temperature of 40°C to 45°C on a heating plate for approximately 30 minutes.

Then a water drop (18°C - 25°C) is dumped down onto the watch glass.

If the watch is leaky, water condensates on the inner surface of the glass.



Field of application

Manufacturing and laboratory.

Main reasons for a faulty water resistance

There can be 3 main reasons for a faulty water-resistance:

- faulty water-resistance due to bad manufacturing (out of truth in the round or in the flat) of the case and of other components.,
- faulty water resistance due to parts of the case and gaskets being deformed in the course of an excess pressure test. This faulty water-resistance only appears in excess pressure tests,
- faulty water-resistance due to inaccurate assembly and a too small fitting pressure of components (seat of the glass and bottom gasket). Such cases of faulty water-resistance can only be detected with low test pressure, especially with partial vacuum.

The stress on the parts is very different according to whether the test is performed under excess pressure or partial vacuum.

Difference between pressure and vacuum tests

Pressure test

The watch is slightly flattened, respectively, the components are pressed against each other.

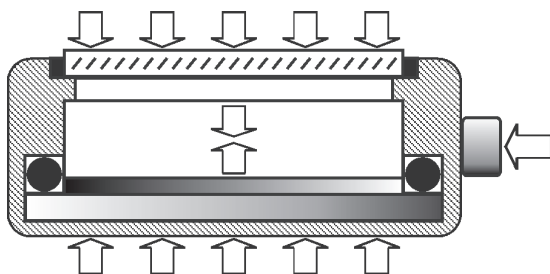

Main reasons / faulty water test

- Defect, old and dirty seals (crown / bottom / glass).
- Porous and old glasses with fissures (acryl).
- Defect crowns.
- None conform glasses.

Vacuum test

The watch is deformed slightly outwards, respectively components resist to the de-pressure by their own maintenance force.

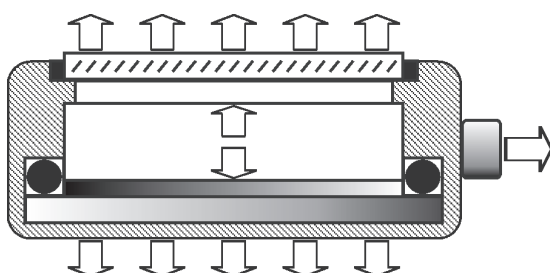

Main reasons / faulty water test

- None conform seals, e.g. too thin (crown / bottom / glass).
- Poorly assembled glasses or seals for crowns, bottoms and battery container.
- Poor tube for crown.

Watch case deformation under pressure

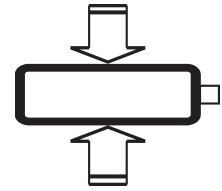
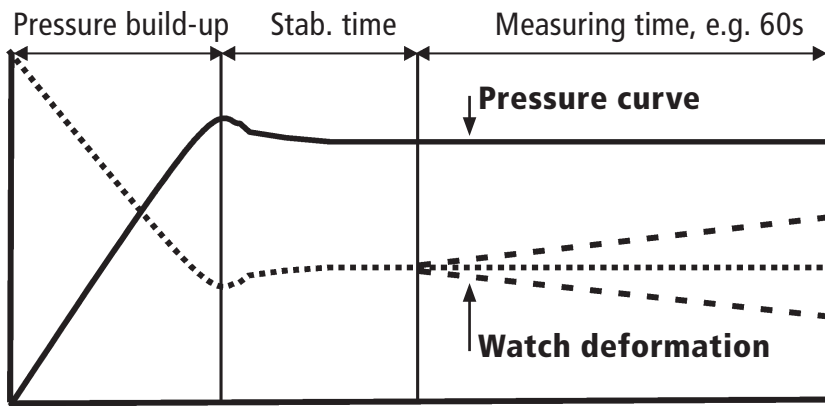



Tightness limit (-value of resilience)
Acceptable test results
Ladys watch: $\leq -2.5\%/min.$ watch ok
Standard gents watch: $\leq -1.0\%/min.$ watch ok

Zero deformation (very hard case) watch ok

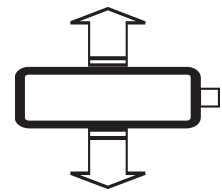
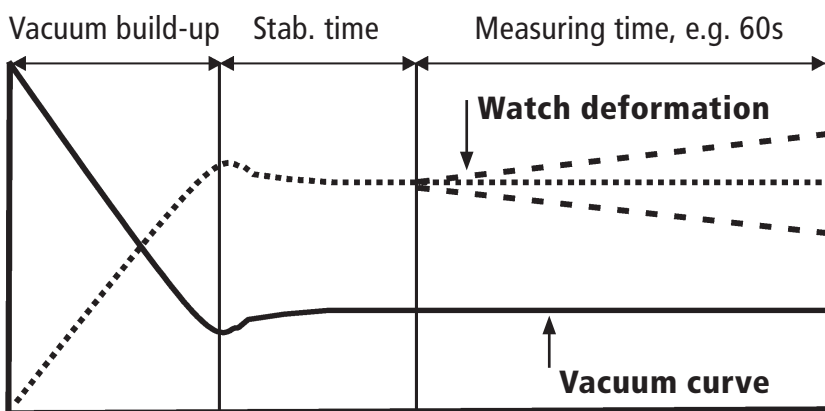
Continuous +deformation during test cycle:
 = high elasticity of the case material, i.e. plastic.
Test result: $+0.1\%/min.$ to $+x\%/min.$
 watch ok

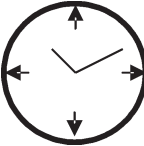
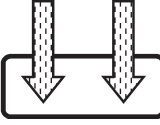
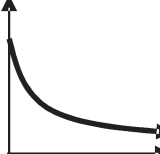

Watch case deformation under vacuum

Methods	Description
Test under pressure	 <p>Tightness test under pressure According to the manufactures specifications. +0.2 to +10 bar</p>
Test under vacuum	 <p>Tightness test under vacuum The vacuum test is primarily designed for detecting small leaks and faulty assembly of case parts. The vacuum test corresponds to normal strain on the watch (swimming, snorkeling etc.).</p>
50 µg air penetration per minute, without taking into account the volume of the watch	 <p>The tightness limit of 50µg of air penetration per minute correspond approximately to a 1% of resilience per minute of the watch case.</p> <p>Parameter for the tightness limit Watch size smaller than 20 mm: -2.0% /min. Watch size 20 - 40 mm: -1.0% /min. Watch size larger than 40 mm: -0.5% /min.</p>
Measuring time	 <p>The measuring time can be set manually from 15 to 600 seconds or on automatic. Witschi recommends the automatic setting.</p>
In consideration of the watch design and the case substance	 <p>Case material and case design influence the deformation. For this reason the Proofmaster S provides 3 different case-parameter settings.</p> <p>Soft for plastic cases and thin-walled metal cases. Stnd for normal and robust watches with metal case. Hard for watches with hard case (hard metal, ceramics) and for diver watches.</p> 

Operating Elements and Display

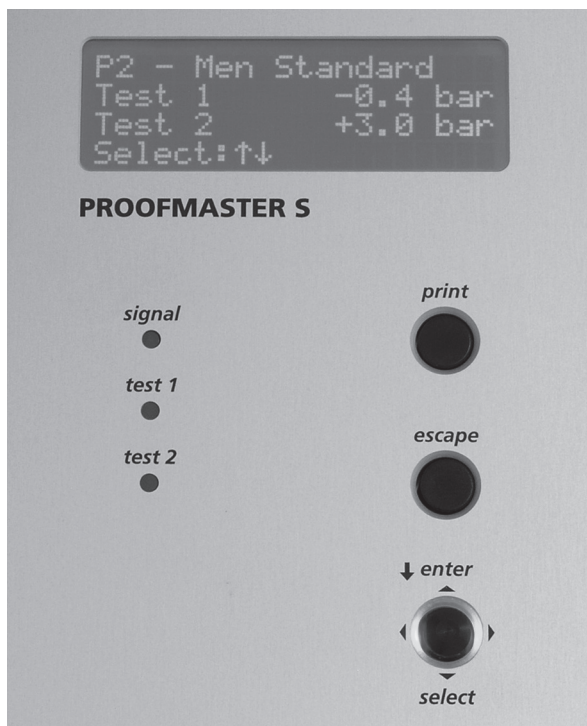

<i>print</i>	Button for printing the measurement log or transferring test results to a PC.
<i>escape</i>	Button to stop a running test or: - back to the program P1 Safe Test - back to the main menu, if you edit a program.
<i>select</i>	Cursor button. Selects a test program or changes a selected parameter by pressing the button up or down. Pressing the button to the left or right selects a parameter in the programming mode, and the Leakfinder program in test and result mode.
<i>enter</i>	Pressing the cursor button vertically confirms the selection and continues to the next input step.
LED <i>signal</i>	Glows yellow as soon as the sensor has been correctly lowered onto the watch.
LED <i>I</i>	Test 1 good (green), poor (red).
LED <i>II</i>	Test 2 good (green), poor (red).

For more details please consult the instruction manual **Proofmaster S**.

Witschi's Proofmaster S has been designed to be a very accurate and professional test instrument. The multi-adjustable parameters make it possible, that almost all available watches can be tested. It provides 18 different test programs, such as:

- 8 predefined programs whose fixed parameters are optimised for different watch types.
- 10 customer-specific programs. The parameters can be adapted in accordance to the requirements.

The predefined and customer-specific test programs can be selected by pressing the cursor button up or down.

Below is an example - Editing a test program. Easy to handle with the **Cursor Button**.

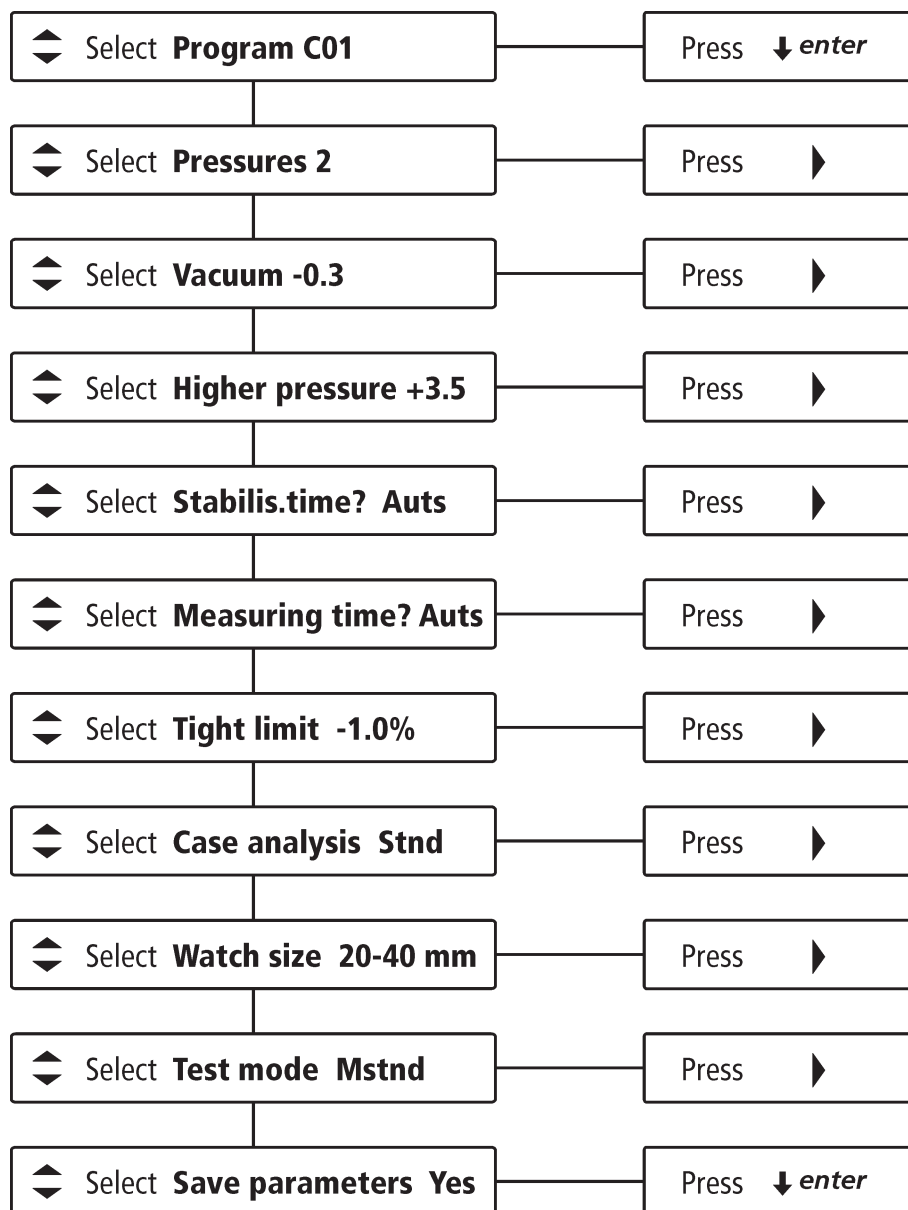

Leak Finder

The special **Leak Finder Program** opens a new dimension for the localisation of watch leakages in water. Watches with or without bracelet can be tested.

How does the Leak Finder Program works?

The watch is set under pressure for a significant amount of time. Let us suppose that the watch is not water-resistant. In this case, the air penetrating into it causes an excess pressure.

When the watch isn't under pressure anymore, the incoming air escapes again through the leak. Bubbles arising when the watch is under water and indicate the position of the leak.

Selecting the Leakfinder Program

The Proofmaster S has two possibilities for selecting and using the Leakfinder Program:

The information for using the Leakfinder Program automatically appears on the display once a watch has completed the previous test with a poor result (leaking).

The customer now has the choice to prepare the watch for locating the leakage in water by means of the Leakfinder Program or not.

The Leakfinder Program may be used as an independent test unrelated to other programs, i.e. without previous test in another test program.

The Leakfinder Program is selected by pushing the cursor to the left or to the right.

Water Test - Procedure

If at the end of the test cycle the message

CONTINUE WATER TEST

appears, then extract immediately the watch from the instrument and place it in a transparent bowl filled with water.

If the watch has a leak, bubbles appear at the position of the leak. If the leak is small, the bubbles form very slowly. It may take several minutes to identify the position of the leak. If possible, use distilled water for the test. It avoids the formation of limestone deposits on the watch.

Caution!

Remove the watch from the water if the formation of bubbles slows down in the case of a bigger leak. Water might penetrate into the watch if the excess pressure in the watch has entirely vanished.



Preset Programs

Below the table of the 8 preset programs, that can not be modified. The pre-set universal programs are optimised for different types of watches.

P1 - Safe Test Test 1 - 0.2 bar Test 2 + 2.0 bar	<p>This program can be used with all types of water-resistant watches without risk of damages.</p> <p>This programme gives unreliable results with hard watches.</p>
P2 - Men Standard Test 1 - 0.4 bar Test 2 + 3.0 bar	<p>Standard program for gent's watches, plastic or metal.</p>
P3 - Ladies Test 1 - 0.4 bar Test 2 + 2.0 bar	<p>Program for small watches (lady's watches).</p>
P4 - Hard Case Test 1 - 0.7 bar Test 2 + 3.0 bar	<p>Program for hard, stable watches with ceramic case and mineral glass</p>
P5 - Jewellery Test 1 - 0.2 bar Test 2 + 1.0 bar	<p>Program for jewellery watches and other watches with less stable cases.</p>
P6 - Diver 100m Test 1 - 0.7 bar Test 2 + 10.0 bar	<p>Test for divers watches that are specified for at least 100m water depth.</p>
P7 - Pressure only Test 1 + 2.0 bar	<p>Pressure only, for quick test.</p>
P8 - Two pressures Test 1 + 0.5 bar Test 2 + 3.0 bar	<p>Double pressure test with one low pressure and a higher pressure. For watches that should not be vacuum tested.</p>

Customer-Specific Programs

The customer-specific programs C01 to C10 can be adapted according to your needs, to take into account the specific characteristics of different watches. Some examples are specified in following table.

Program	Size Dial diameter	Vacuum (bar)	Pressure (bar)	Stabilisation time	Measuring time	Tolerance -% resilience	Watch case
C1	Big size standard > 40mm	-0.4	+3.0 to +5.0	Autts	Autts	-0.5%	Standard
C2	Big size diver > 40mm	-0.6 to -0.7	+10.0	Autts	Autts	-0.5%	Standard
C3	Big size hard > 40 mm	-0.5 to -0.6	+3.0 to +5.0	Autts	Autts	-0.5%	Hard
C4	Gents standard 20 - 40mm	-0.4	+3.0 to +5.0	Autts	Autts	-1.0%	Standard
C5	Gents diver 20 - 40mm	-0.6 to -0.7	+10.0	Autts	Autts	-1.0%	Standard
C6	Gents hard 20 - 40 mm	-0.5 to -0.6	+3.0 to +5.0	Autts	Autts	-1.0%	Hard
C7	Ladies standard < 20mm	-0.4	+3.0 to +5.0	Autts	Autts	-1.0% to -2.0%	Standard
C8	Ladies diver < 20mm	-0.6 to -0.7	+10.0	Autts	Autts	-1.0% to -2.0%	Standard
C9	Ladies hard < 20mm	-0.5 to -0.6	+3.0 to +5.0	Autts	Autts	-1.0% to -2.0%	Hard
C10	Gents soft 20-40 mm Flat Gents soft 20 - 40mm Ladies soft < 20mm	-0.4 -0.4 -0.4	+2.0 to +3.0 +1.0 to +2.0 +2.0 to +3.0	Autts Autts Autts	Autts Autts Autts	-1.0% -1.0% -1.5% to -2.0%	Soft Soft Soft

Too high pressure or vacuum may damage the watch being tested.

Refer to manufacturer's specification.

Watch case:

Standard for normal and robust watches with metal case

Hard for watches with hard case (hard metal, ceramics) and for diver watches.

Soft for plastic cases and thin metal cases

Table - Forces on Watches' Glass and Bottom

The table contains the internal (**vacuum**) and external (**pressure**) force in **Kilograms**, which acts on the glass and bottom of the watch case.









$$\text{Force} = P \times 1.02 \times r^2 \times 3.1416$$

Vacuum test (bar)	Internal force on bottom and glass Ø 30 mm	Vacuum test (bar)	Internal force on bottom and glass Ø 25 mm	Vacuum test (bar)	Internal force on bottom and glass Ø 20 mm
-0.2	1.44	-0.2	1.00	-0.2	0.64
-0.3	2.16	-0.3	1.50	-0.3	0.96
-0.4	2.88	-0.4	2.00	-0.4	1.28
-0.5	3.60	-0.5	2.50	-0.5	1.60
-0.6	4.33	-0.6	3.00	-0.6	1.92
-0.7	5.05	-0.7	3.50	-0.7	2.24
-0.8	5.77	-0.8	4.01	-0.8	2.56

Pressure test (bar)	External force on bottom and glass Ø 30 mm	Pressure test (bar)	External force on bottom and glass Ø 25 mm	Pressure test (bar)	External force on bottom and glass Ø 20 mm
0.5	3.60	0.5	2.50	0.5	1.60
1.0	7.21	1.0	5.01	1.0	3.20
1.5	10.81	1.5	7.51	1.5	4.81
2.0	14.42	2.0	10.01	2.0	6.41
2.5	18.02	2.5	15.52	2.5	8.10
3.0	21.55	3.0	15.02	3.0	9.61
3.5	25.23	3.5	17.52	3.5	11.22
4.0	28.84	4.0	20.03	4.0	12.82
4.5	32.44	4.5	22.55	4.5	14.42
5.0	36.05	5.0	25.03	5.0	16.02
6.0	43.26	6.0	30.04	6.0	19.26
7.0	50.47	7.0	35.05	7.0	22.46
8.0	57.68	8.0	40.06	8.0	25.64
9.0	64.29	9.0	45.06	9.0	28.84
10.0	72.10	10.0	50.07	10.0	31.40

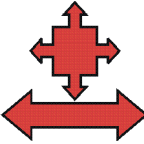
Witschi's Measuring Tips



Test and Check Procedure	Explanations
Wind up the watch by turning 10-15x the crown. Before testing the watch should run for approximately 20 minutes.	 <p>The measured rate values become stable. A regular diagram tracing is displayed.</p>
Check that the hands are not in the position just before midnight (date changing)	 <p>The date changing may momentary influence and falsify the measurement of the rate accuracy.</p>
Push Crown to "0" (inside) position.	 <p>Movement may stop in pulled position.</p>
If possible, the watch should be demagnetised with a suitable device, e.g. Witschi's Teslascope .	 <p>A greater number of steel components can be magnetised and can disturb the rate accuracy significantly.</p>
Start the rate measurements in vertical positions - 6h, 9h, 12h and 9h. Then in horizontal positions dial upwards and downwards.	 <p>The stabilisation time within the vertical and horizontal positions is shorter as from a vertical to a horizontal position and vice versa.</p>
Set a stabilisation time of ~15 s and measuring time of min. 20 s per test position. Start the measurement.	 <p>For longer stabilisation and measuring times follow a more stable rate result.</p>
Check the date mechanism and the watches' power reserve.	 <p>Functional test.</p>
Check self-winding mechanism of automatic watches with a simulator.	 <p>Functional test.</p>
Check the watch after 24 hours, rate accuracy, time & date display, etc.	 <p>Functional test after 24 hours.</p>

<p>Test and Check Procedure</p>	<p>Explanations</p>
<p>Visual inspection of the watch movement regarding cleanness, in particular the rotor and the mechanical parts.</p>	<p>Remove any impurity, metal particles etc. Those may block the gear train or the step motor.</p>
<p>Check the battery voltage. Nominal and voltage under load must correspond to manufacturers specification.</p>	<p>The battery tests should occur with a suitable tester. Tests with an ordinary multimeter are not reliable and not recommended.</p>
<p>Clean the battery contacts, especially the -contact and the battery emplacement.</p>	<p>Running out acids and salt crystals can oxidize and destroy the contacts and other parts.</p>
<p>Test time and date (quick date) setting, the reset function as well as the different crown positions.</p> <p>Check the hands setting in watches' dial down position.</p>	<p>When the hand setting shaft is pulled, the power saving function is activated (motor pulses are disabled). Almost all watches are provided with the reset function.</p> <p>The upper hand may touch the glass, or a hand can affect another hand.</p>
<p>Place the watch on the sensor and check if the signal of the quartz oscillator and/or motor pulses are present.</p>	<p>If no signal is detected means that one of the moduls' component is defective (IC, quartz, etc.).</p>
<p>Analogue quartz watches Place the watch on the sensor. Start the rate measurement if motor pulses are present.</p>	<p>No pulses: defective coil or PCB. Pulses are ok, but hands don't move: check motor, gear train and hand train.</p>
<p>Digital quartz watches Place the watch on the sensor. Start the rate measurement if the signal is present (quartz or LCD).</p>	<p>No signal and no display. Replace electronic module.</p>

<p>Test and Check Procedure</p>	<p>Explanations</p>
<p>Visual inspection of the watch case, glass, crown, pushers, gasket seals etc. on damage and dirt.</p>	<p>Watches with a cracked glass should not be tested - a breakup of the glass may damage hands and dial.</p>
<p>Crown must be in position "0" position. If necessary push or screw it to this position.</p>	<p>Pay special attention to the position of screwed crowns.</p>
<p>A watch carried at the wrist should not be examined immediately. Also before testing, a watch should be kept only for a very short time in the hand. It must have the same ambient temperature as the test device.</p>	<p>Temperature fluctuations whilst the test cycle is running may falsify the test result.</p>
<p>Remove any adhesive label/protection from the watches' glass and/or bottom.</p>	<p>Embedded air in labels falsifies the test results.</p>
<p>Test program The test parameter setting must correspond to manufacturers specification. A twofold test (pressure and vacuum) is beneficial.</p>	<p>Vacuum test: fast location of small leakages (seals etc.). Pressure test: indicates the state of the case.</p>
<p>Placing the watch on sensor - Dial upwards for watches with passably flat glass. - Dial downwards for watches with strongly curved glass (cambered case).</p>	
<p>If the test result is negative, it is recommended to perform a second test. But not immediately after the first test cycle. It may take up to 30 minutes or more until the case is re-stabilised after it has been deformed.</p>	<p>Before starting a re-test we recommend to pull and to rotate a few turns the crown, then push it back.</p>
<p>If possible, printout the test results.</p>	<p>Quality assurance, traceability etc.</p>